



Orthopedic *Instruments*

Orthopädische Instrumente
Instruments orthopédiques
Instrumentos ortopédicos
Strumenti ortopedici

20+
Years of
TIG
Performance

Mark Approved



Index

	<i>Page</i>
Probes	2
Suction tubes	2
Scissors, delicate	2
Scissors, standard	3
Scissors, TC	4,5
Scalpel handles	6
Dissecting forceps, standard	7
Dissecting forceps, TC	7
Dressing and sponge holding forceps	8
Hemostatic forceps	8-11
Dissecting & ligature forceps	12
Towel forceps	12
Needle holders, standard	13
Needle holders, TC	13,14
Retractors, Hand	15
Retractors, self retaining	16
Sterilization	17,18

Inhaltsverzeichnis

	<i>Seite</i>
Sonden	2
Saugkanülen	2
Feine scheren	2
Standard scheren	3
TC-scheren	4,5
Skalpellgriffe	6
Anatomische pinzetten	7
TC-Pinzetten	7
Tupfer-und schwammzangen	8
Arterienklemmen	8-11
Präparier & ligaturklemmen	12
Tuchklemmen	12
Standard Nadelhalter	13
TC-Nadelhalter	13,14
Wundhaken	15
Wundspreizer, selbsthaltend	16
Sterilisation	17,18

Indice

	<i>Page</i>
Sondas	2
Cánulas de aspiración	2
Tijeras finas	2
Tijeras standard	3
Tijeras-TC	4,5
Mangos de bisturios	6
Pinzas de disección	7
Pinzas-TC	7
Pinzas para tapones y esponjas	8
Pinzas hemostáticas	8-11
Pinzas para preparaciones y ligaduras	12
Pinzas para compresas y de camp	12
Porta agujas, standard	13
Porta agujas-TC	13,14
Separadores	15
Separadores con retenida automática	16
Esterilizacion	17,18

Sommaire

	<i>Pagina</i>
Sondes	2
Canules à aspiration	2
Ciseaux fins	2
Ciseaux standard	3
Ciseaux-TC	4,5
Manches pour bistouris	6
Pinces à disséquer	7
Pinces-TC	7
Pinces à tampons et éponges	8
Pinces hémostatique	8-11
Pince à dissection et à ligatures	12
Pinces à compresses et à champs	12
Porte-aiguilles standard	13
Porte-aiguilles-TC	13,14
Ecarteurs	15
Ecarteurs autostatiques	16
Sterilisation	17,18

Index

	<i>Page</i>
Plaster of paris	20,21
Mallets	22-24
Bone files, rasps	25
Elevators	26-30
Raspatories	28-30
Bone levers	31-33
Bone cutting forceps	34-36
Bone holding forceps	37-43
Amputation & resection saws	44
Wire forceps	45-47
Chisels, gouges & osteotomes	48-54
Bone curettes	55-59
Bone rongeurs	60-67
Hand bone drills	68
Finger ring saws	68
Nail instruments	68

Inhaltsverzeichnis

	<i>Seite</i>
Gips / verband	20,21
Hämmer	22-24
Knochenfeilen, raspeln	25
Elevatoren	26-30
Raspatorien	28-30
Knochenhebel	31-33
Knochensplitterzangen	34-36
Knochenhalte-zangen	37-43
Amputations & resektionssägen	44
Drahtzangen	45-47
Flachmeißel, hohlmeißel & osteotome	48-54
Scharfe löffel	55-59
Hohlmeißelzangen	60-67
Handbohrapparate	68
Fingerringssägen	68
Nagelzange	68

Indice

	<i>Page</i>
Vendajes enyesados	20,21
Martillos y mazos	22-24
Limas para huesos, Escofinas	25
Elevadores	26-30
Periostótomos	28-30
Elevadores para huesos	31-33
Pinzas cortantes para huesos	34-36
Pinzas para huesos	37-43
Sierras para amputación y resección	44
Pinzas para hilos	45-47
Cinceles, Gubias y Osteótomos	48-54
Cucharillas cortantes	55-59
Pinzas gubias	60-67
Perforadores de mano para huesos	68
Sierras para abrir anillos	68
Pinza para uñas	68

Sommaire

	<i>Pagina</i>
Bandage plâtrès	20,21
Maillets	22-24
Limes à os, Râpes à os	25
Elévateurs	26-30
Rugines	28-30
Levier à os	31-33
Pinces coupantes	34-36
Daviers	37-43
Scies à amputation et résection	44
Pinces à fil	45-47
Ciseaux-Burins, Gouges et Ostéotomes	48-54
Curettes tranchantes	55-59
Pinces gouges	60-67
Perforateur à main	68
Scies pour bagues et	68
Pince à ongle	68

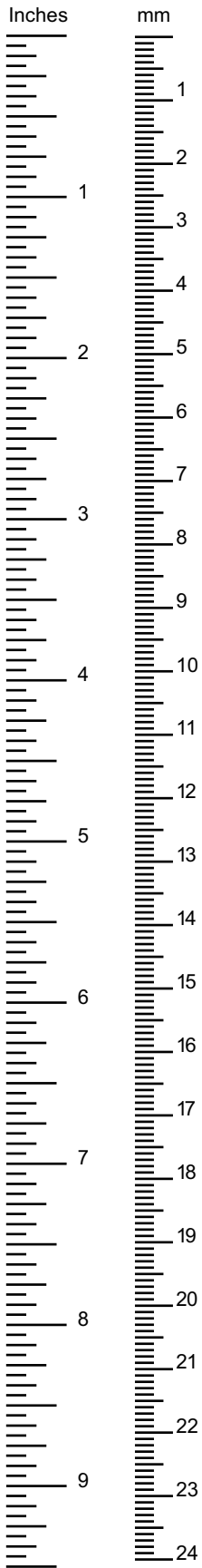

GENERAL SURGERY

Probes

Sonden
Sondas
Sondes

Suction tubes

Saugkanülen
Cánulas de aspiración
Canules à aspiration



TB. 02.13 13 cm
TB. 02.14 14.5 cm
TB. 02.16 16 cm
TB. 02.18 18 cm

TB. 07.13 13 cm
TB. 07.14 14.5 cm
TB. 07.18 18 cm

YANKAUER
TB. 30.00

POOLE
TB. 34.30
22 cm

POOLE
TB. 35.23
22 cm

Delicate scissors

Feine Scheren
Tijeras finas
Ciseaux fins

Operating and dissecting scissors

Operations - und Präparierscheren
Tijeras para cirugía y preparaciones
Ciseaux à chirurgie et dissection



IRIS
Straight TC. 01.09 9 cm
TC. 01.10 10.5cm
TC. 01.11 11.5cm
Curved TC. 02.09
TC. 02.10
TC. 02.11



Blunt/Blunt
Straight TC. 14.11 11.5cm
TC. 14.13 13 cm
TC. 14.14 14.5cm
TC. 14.16 16.5cm
Curved TC. 18.11
TC. 18.13
TC. 18.14
TC. 18.16



Sharp/Sharp
Straight TC. 15.11 11.5cm
TC. 15.13 13 cm
TC. 15.14 14.5cm
TC. 15.16 16.5cm
Curved TC. 19.11
TC. 19.13
TC. 19.14
TC. 19.16



Sharp/Blunt
Straight TC. 16.11 11.5cm
TC. 16.13 13 cm
TC. 16.14 14.5cm
TC. 16.16 16.5cm
Curved TC. 17.11
TC. 17.13
TC. 17.14
TC. 17.16



MAYO-HARRINGTON
Straight TC. 24.14 14 cm
TC. 24.15 15.5 cm
TC. 24.17 17 cm
TC. 24.23 23 cm
Curved TC. 25.14
TC. 25.15
TC. 25.17
TC. 25.23

MAYO-HARRINGTON
Straight TC. 24.60 20cm
TC. 24.63 23cm
Curved TC. 25.60
TC. 25.63

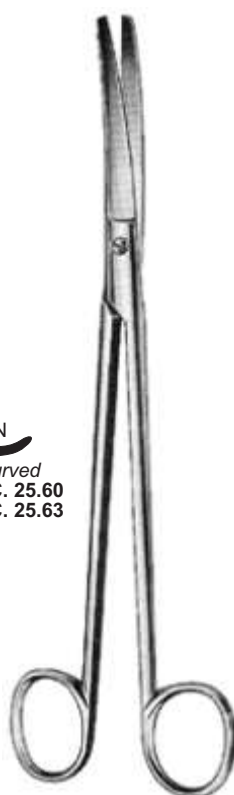

MAYO-STILLE
Straight TC. 28.15 15cm
TC. 28.17 17cm
TC. 28.23 23cm
Curved TC. 30.15
TC. 30.17
TC. 30.23

Operating and dissecting scissors, PROLONG TC®

Operations - und Präparierscheren, PROLONG TC®

Tijeras para cirugía y preparaciones, PROLONG TC®

Ciseaux à chirurgie et dissection, PROLONG TC®

Scissors with tungsten carbide cutting edges

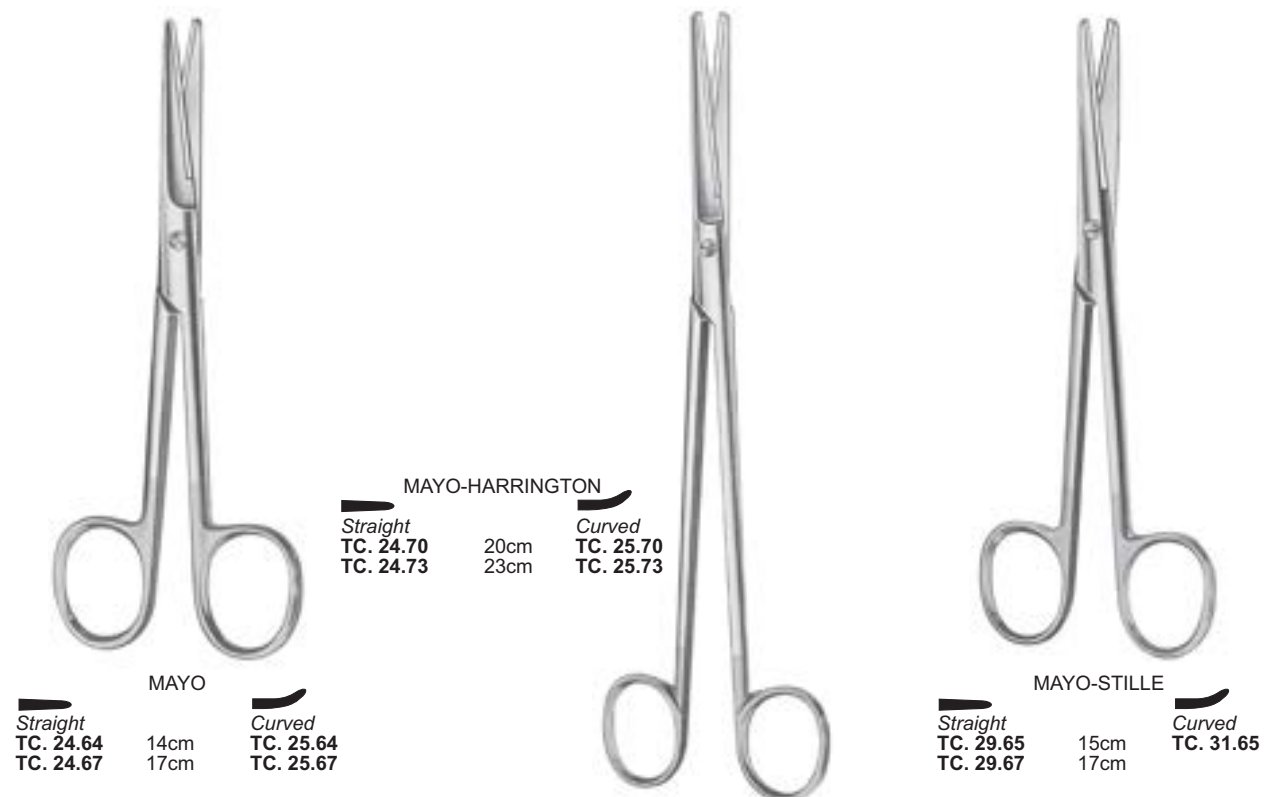

Dissecting scissors, PROLONG TC®
 Präparierscheren, PROLONG TC®
 Tijeras para preparaciones, PROLONG TC®
 Ciseaux à dissection, PROLONG TC®

Scissors with tungsten carbide cutting edges



METZENBAUM (LAHEY)
 Straight PC. 36.64 14 cm Curved PC. 37.64



METZENBAUM
 Straight PC. 38.68 18 cm Curved PC. 39.68
 PC. 38.70 20 cm PC. 39.70



NELSON (METZENBAUM)
 Straight PC. 40.73 23 cm Curved PC. 41.73
 PC. 40.76 26 cm PC. 41.76
 PC. 40.80 30 cm PC. 41.80

Scalpel handles
Skalpellgriffe
Mangos de bisturios
Manches pour bistouris



NO. 3
PE. 04.03
12 cm



NO. 4
PE. 09.04
13 cm



NO. 7
PE. 05.07
16 cm



NO. 3 L
PE. 07.13
21 cm

Dissecting forceps
 Anatomische Pinzetten
 Pinzas de disección
 Pincés à disséquer

Dissecting forceps, PROLONG TC®
 Anatomische Pinzetten, **PROLONG TC®**
 Pinzas de disección, **PROLONG TC®**
 Pincés à disséquer, **PROLONG TC®**

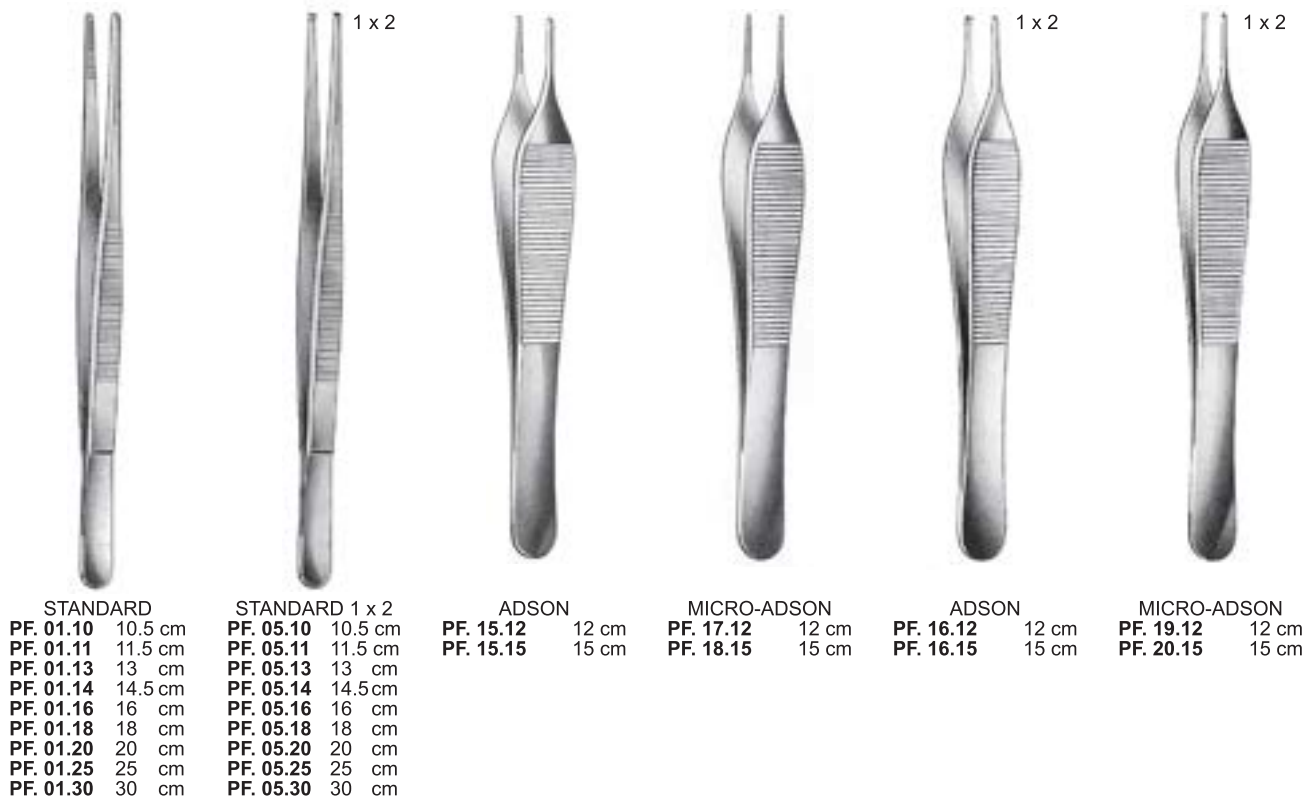

Forceps with tungsten carbide tips

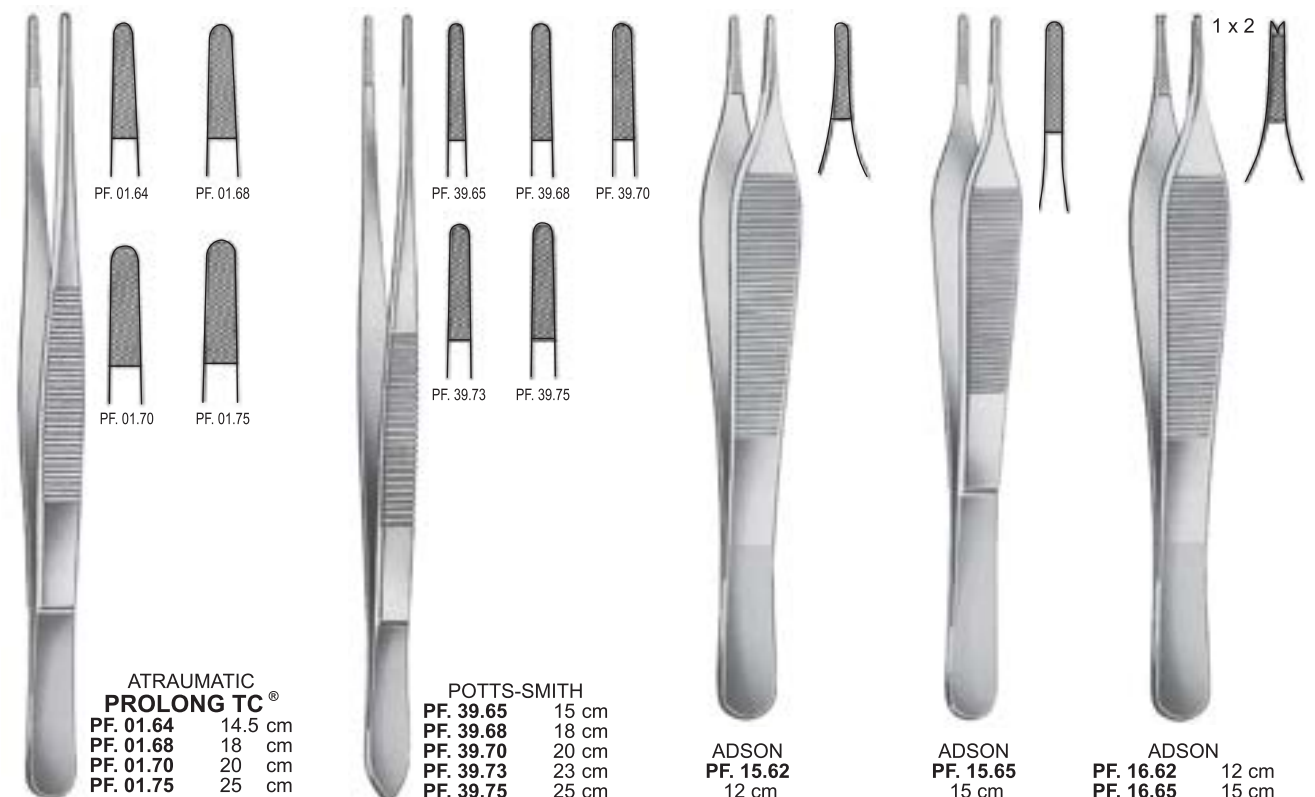

Dressing & sponge holding forceps

Tupfer- und Schwammzangen
 Pinzas para tapones y esponjas
 Pincas à tampons et éponges

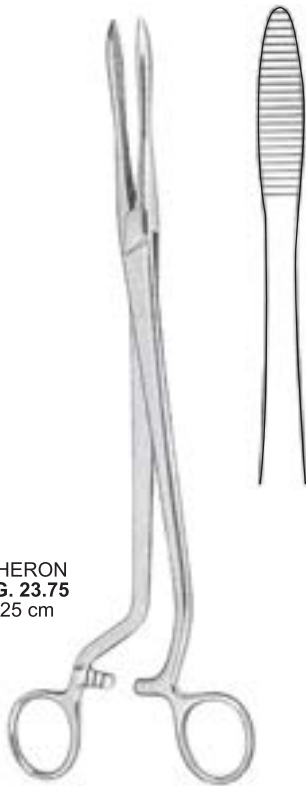

CHERON
 PG. 23.75
 25 cm

Hemostatic forceps

Arterienklemmen
 Pinzas hemostáticas
 Pincas hémostatique



PG. 36.19
 PG. 37.25

FOERSTER
Straight PG. 36.18 18 cm
Curved PG. 36.19 24 cm
 PG. 37.24 PG. 37.25



HALSTED-MOSQUITO
Straight PH. 10.12 12.5 cm
Curved PH. 11.12



RANKIN-KELLY
Straight PH. 42.14 14 cm
 PH. 44.16 16 cm
Curved PH. 43.14
 PH. 45.16



RANKIN-CRILE
Straight PH. 46.14 14 cm
 PH. 48.16 16 cm
Curved PH. 47.14
 PH. 49.16

Hemostatic forceps

Arterienklemmen
 Pinzas hemostáticas
 Pincas hémostatique

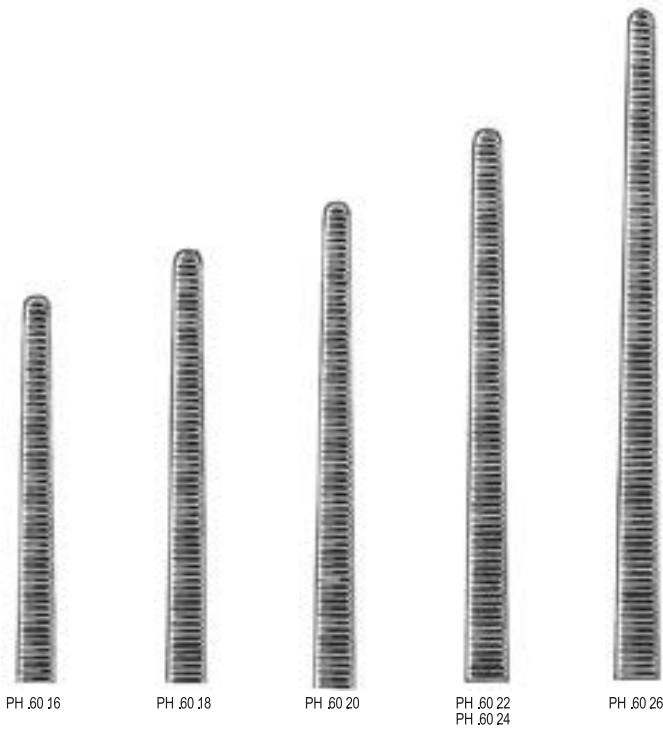

PH.60.16

PH.60.18

PH.60.20

PH.60.22
PH.60.24

PH.60.26



ROCHESTER-PEAN

<i>Straight</i>		<i>Curved</i>
PH. 60.16	16 cm	PH. 56.16
PH. 60.18	18 cm	PH. 56.18
PH. 60.20	20 cm	PH. 56.20
PH. 60.22	22 cm	PH. 56.22
PH. 60.24	24 cm	PH. 56.24
PH. 60.26	26 cm	PH. 56.26

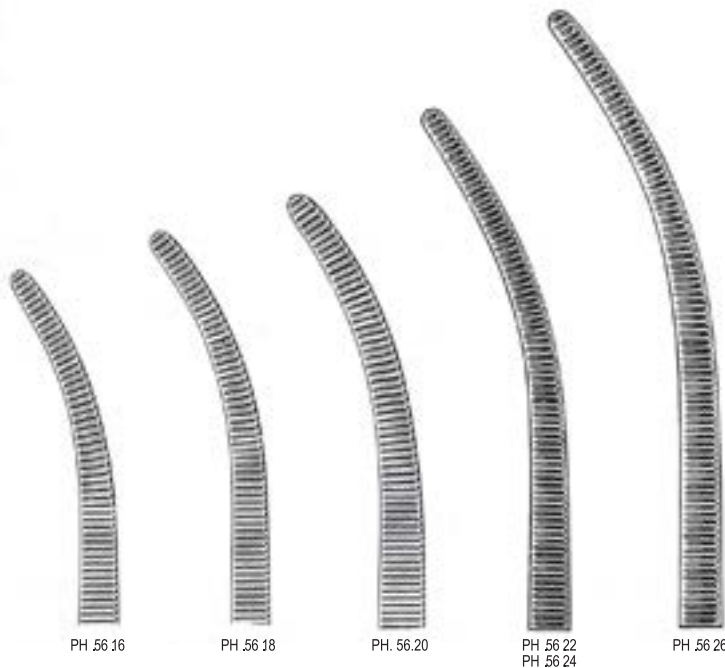

PH.56.16

PH.56.18

PH.56.20

PH.56.22
PH.56.24

PH.56.26

Hemostatic forceps

Arterienklemmen

Pinzas hemostáticas

Pinces hémostatique



PH. 62.16



PH. 62.18



PH. 62.20



PH. 62.22
PH. 62.24



PH. 62.26



PH. 63.16



PH. 63.18



PH. 63.20



PH. 63.22
PH. 63.24

PH. 63.26



ROCHESTER-OGHSNER

Straight

PH. 62.16

16 cm

PH. 62.18

18 cm

PH. 62.20

20 cm

PH. 62.22

22 cm

PH. 62.24

24 cm

PH. 62.26

26 cm

Curved

PH. 63.16

PH. 63.18

PH. 63.20

PH. 63.22

PH. 63.24

PH. 63.26

Hemostatic forceps

Arterienklemmen
Pinzas hemostáticas
Pincas hémostatique

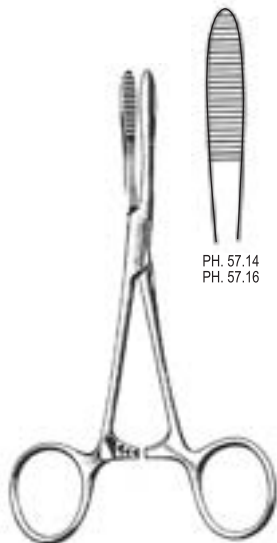

PEAN
PH. 57.14 14 cm
PH. 57.16 16 cm

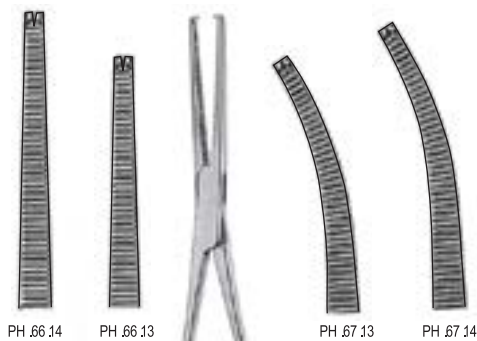

PH. 66.14 PH. 66.13 PH. 67.13 PH. 67.14

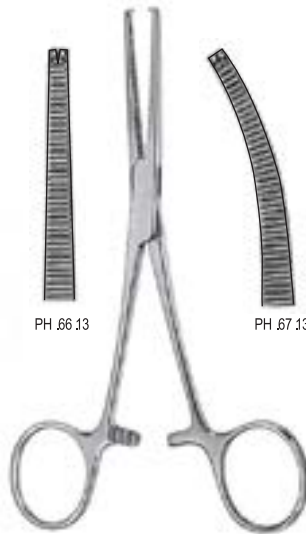

KOCHER
Straight PH. 66.13 13 cm
PH. 66.14 14 cm
Curved PH. 67.13 13 cm
PH. 67.14 14 cm



MOYNIHAN
PH. 73.23 23 cm
PH. 73.24 24 cm

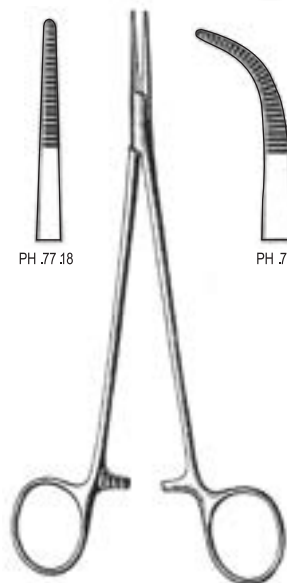

HALSTED (ADSON)
Straight PH. 77.18 18 cm
Curved PH. 78.18

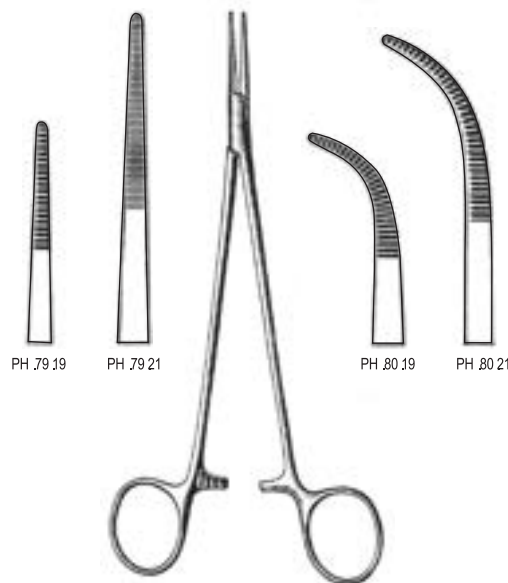

ADSON
Straight PH. 79.19 18.5 cm
PH. 79.21 18.5 cm
Curved PH. 80.19
PH. 80.21

Dissecting & ligature forceps

Präparier- & Ligaturklemmen

Pinzas para preparaciones y ligaduras

Pince à dissection et à ligatures

Towel forceps

Tuchklemmen

Pinzas para compresas y de campo

Pinces à compresses et à champs



PI. 03.14

MIXTER-BABY
PI. 03.14 14 cm



PI. 06.18

PI. 06.23

MIXTER
PI. 06.18 18 cm
PI. 06.23 23 cm



PI. 08.14

PI. 08.18

PI. 08.20

GEMINI
PI. 08.14 14 cm
PI. 08.18 18 cm
PI. 08.20 20 cm



BACKHAUS
PI. 25.08 8 cm
PI. 25.10 11 cm
PI. 26.13 13 cm
PI. 26.15 15 cm

Needle holders

Nadelhalter
Porta agujas
Porte aiguilles

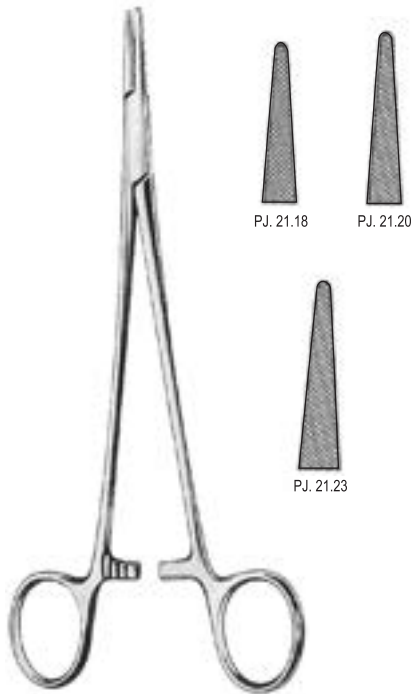

CRILE-WOOD
PJ. 21.18 18 cm
PJ. 21.20 20 cm
PJ. 21.23 23 cm

Needle holders, PROLONG TC®

Nadelhalter, PROLONG TC®
Porta agujas, PROLONG TC®
Porte aiguilles, PROLONG TC®

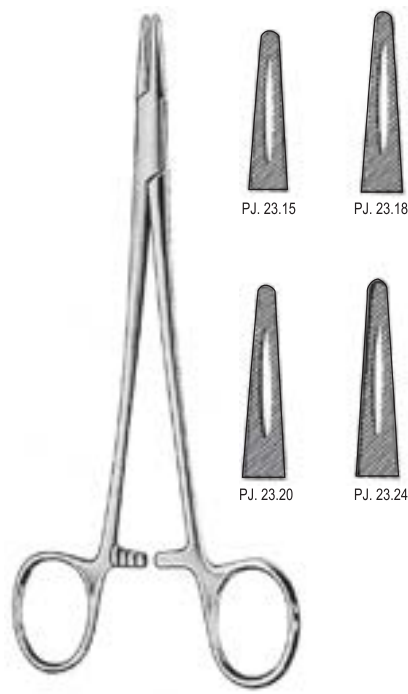

MAYO-HEGAR
PJ. 23.15 15 cm
PJ. 23.18 18 cm
PJ. 23.20 20 cm
PJ. 23.24 24 cm



CRILE-WOOD
PJ. 34.15 15 cm

Needle holders with tungsten carbide jaws

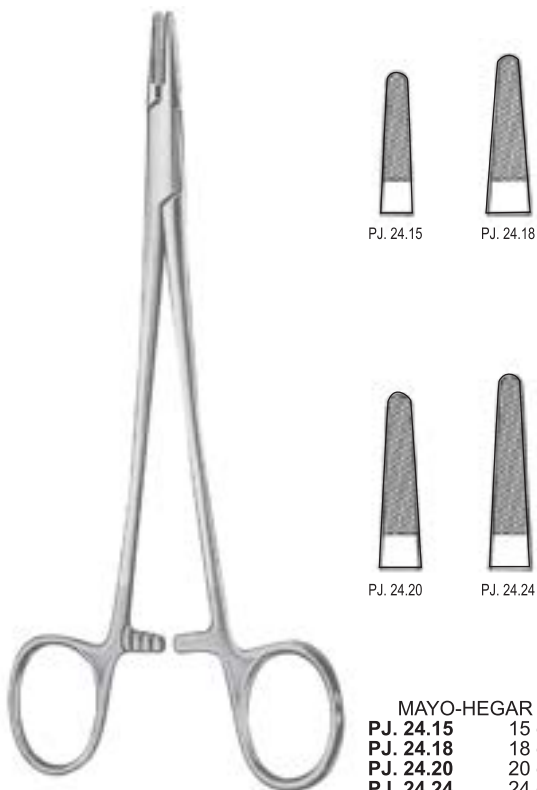

MAYO-HEGAR
PJ. 24.15 15 cm
PJ. 24.18 18 cm
PJ. 24.20 20 cm
PJ. 24.24 24 cm

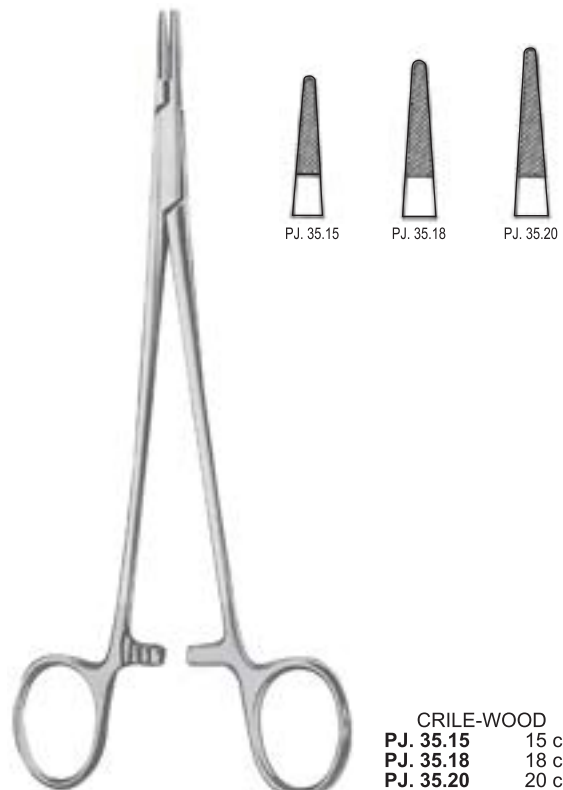

CRILE-WOOD
PJ. 35.15 15 cm
PJ. 35.18 18 cm
PJ. 35.20 20 cm

Needle holders, PROLONG TC®

Nadelhalter, **PROLONG TC®**

Porta agujas, **PROLONG TC®**

Porte aiguilles, **PROLONG TC®**

Needle holders with tungsten carbide jaws

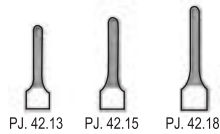

PJ. 42.13 PJ. 42.15 PJ. 42.18

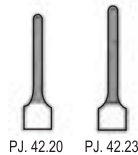

PJ. 42.20 PJ. 42.23



**RYDER
(FRENCH EYE)**
PJ. 42.13 13 cm
PJ. 42.15 15 cm
PJ. 42.18 18 cm
PJ. 42.20 20 cm
PJ. 42.23 23 cm

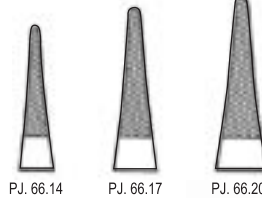

PJ. 66.14 PJ. 66.17 PJ. 66.20



MATHIEU-KOCHER
PJ. 66.14 14 cm
PJ. 66.17 17 cm
PJ. 66.20 20 cm

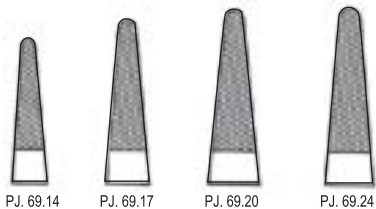

PJ. 69.14 PJ. 69.17 PJ. 69.20 PJ. 69.24



MATHIEU
PJ. 69.14 14 cm
PJ. 69.17 17 cm
PJ. 69.20 20 cm
PJ. 69.24 24 cm

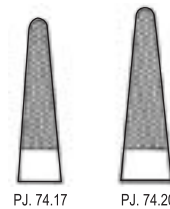

PJ. 74.17 PJ. 74.20



MATHIEU
PJ. 74.17 17 cm
PJ. 74.20 20 cm

Retractors

Wundhaken
Separadores
Ecarteurs

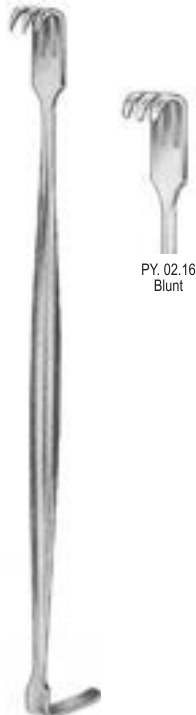

PY. 02.16
Blunt

SENN-MUELLER
PY. 01.16 16 cm Sharp
PY. 02.16 16 cm Blunt



FARABEUF-BABY
PY. 46.12 12 cm



FARABEUF
PY. 47.15 15 cm



VOLKMANN
22 cm



PY. 59.22 Sharp
PY. 60.22 Blunt



PY. 59.23 Sharp
PY. 60.23 Blunt



PY. 59.24 Sharp
PY. 60.24 Blunt



LANGENBECK
PY. 71.10 21 cm
PY. 71.13 21 cm
PY. 71.16 21 cm



PY. 71.10
PY. 72.10
10 x 40 mm



PY. 71.13
PY. 72.13
13 x 42 mm



PY. 71.16
PY. 72.16
16 x 42 mm



LANGENBECK
PY. 72.10 21 cm
PY. 72.13 21 cm
PY. 72.16 21 cm

Self-retaining retractors

Wundspreizer, selbsthaltend
 Separadores con retenida automática
 Ecarteurs autostatiques

Laminectomy retractors

Laminektomie-Wundspreizer
 Separadores para laminectomía
 Ecarteurs pour laminectomie

3 x 4 Prongs



JANSEN
 Sharp PZ. 04.10 10 cm Blunt PZ. 05.20

3 x 4 Prongs



WEITLANER
 Sharp PZ. 29.13 13 cm Blunt PZ. 30.13
 PZ. 29.16 16.5 cm PZ. 30.16
 PZ. 20.20 20 cm PZ. 20.21

4 x 5 Prongs



ADSON
 Sharp PZ. 38.31 31 cm Blunt PZ. 38.32

28 mm deep

4 x 4 Prongs



BECKMANN-ADSON
 31 cm
 Sharp PZ. 40.25 25 mm deep PZ. 40.26 Blunt PZ. 40.46
 PZ. 40.45 44 mm deep

7 x 7 Prongs



BECKMANN-EATON
 32 cm
 PZ. 40.50 50 mm deep

Sterilization

Sterilisation
Esterilizacion
Sterilisation



CHEATLE
PR. 03.27 27 cm

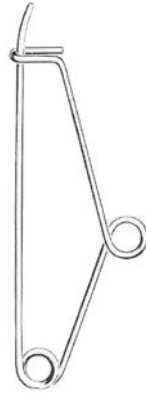

MAYO
PR. 10.14 14 cm



SCHIMMELBUSCH

	∅	h
PR. 25.14	14	14 cm
PR. 25.16	16	15 cm
PR. 25.19	19	16 cm
PR. 25.20	19	19 cm
PR. 25.24	24	12 cm
PR. 25.25	24	16 cm
PR. 25.27	24	24 cm
PR. 25.29	29	16 cm
PR. 25.30	29	24 cm
PR. 25.34	34	16 cm
PR. 25.35	34	24 cm
PR. 25.39	39	14 cm
PR. 25.40	39	19 cm
PR. 25.41	39	29 cm



KONRICH

	∅	h
PR. 26.14	14	14 cm
PR. 26.16	16	15 cm
PR. 26.19	19	16 cm
PR. 26.20	19	19 cm
PR. 26.24	24	12 cm
PR. 26.25	24	16 cm
PR. 26.27	24	24 cm
PR. 26.29	29	16 cm
PR. 26.30	29	24 cm
PR. 26.34	34	16 cm
PR. 26.35	34	24 cm
PR. 26.39	39	14 cm
PR. 26.40	39	19 cm
PR. 26.41	39	29 cm

Inserts for KONRICH

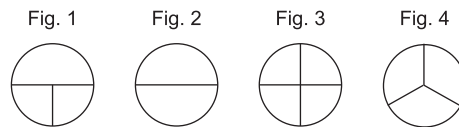

				∅	h
PR. 27.14	PR. 28.14	PR. 29.14	PR. 30.14	14	14 cm
PR. 27.16	PR. 28.16	PR. 29.16	PR. 30.16	16	15 cm
PR. 27.19	PR. 28.19	PR. 29.19	PR. 30.19	19	16 cm
PR. 27.20	PR. 28.20	PR. 29.20	PR. 30.20	19	19 cm
PR. 27.24	PR. 28.24	PR. 29.24	PR. 30.24	24	12 cm
PR. 27.25	PR. 28.25	PR. 29.25	PR. 30.25	24	16 cm
PR. 27.27	PR. 28.27	PR. 29.27	PR. 30.27	24	24 cm
PR. 27.29	PR. 28.29	PR. 29.29	PR. 30.29	29	16 cm
PR. 27.30	PR. 28.30	PR. 29.30	PR. 30.30	29	24 cm
PR. 27.34	PR. 28.34	PR. 29.34	PR. 30.34	34	16 cm
PR. 27.35	PR. 28.35	PR. 29.35	PR. 30.35	34	24 cm
PR. 27.39	PR. 28.39	PR. 29.39	PR. 30.39	39	14 cm
PR. 27.40	PR. 28.40	PR. 29.40	PR. 30.40	39	19 cm
PR. 27.41	PR. 28.41	PR. 29.41	PR. 30.41	39	29 cm

Sterilization
 Sterilisation
 Esterilizacion
 Sterilisation



- PAF. 04.15 150 x 100 x 25 mm
- PAF. 04.20 200 x 150 x 40 mm
- PAF. 04.25 250 x 200 x 50 mm
- PAF. 04.30 300 x 250 x 50 mm
- PAF. 04.35 350 x 300 x 50 mm
- PAF. 04.40 400 x 300 x 50 mm
- PAF. 04.45 450 x 350 x 50 mm



- PF. 08.85 85 x 85 mm
- PF. 08.90 100 x 100 mm
- PF. 08.92 120 x 120 mm
- PF. 08.95 150 x 150 mm



- PAF. 10.17 170 x 100 x 35 mm
- PAF. 10.25 250 x 140 x 40 mm
- PAF. 10.27 275 x 150 x 45 mm
- PAF. 10.30 305 x 140 x 50 mm



- PAF. 12.07 165 x 60 mm
- PAF. 12.10 175 x 70 mm
- PAF. 12.25 225 x 90 mm
- PAF. 12.45 275 x 115 mm
- PAF. 12.60 290 x 125 mm
- PAF. 12.85 345 x 125 mm
- PAF. 12.91 380 x 125 mm
- PAF. 12.94 405 x 150 mm



- PAF. 15.30 30 x 90 mm
- PAF. 15.50 50 x 100 mm
- PAF. 15.51 50 x 120 mm
- PAF. 15.56 60 x 130 mm
- PAF. 15.76 75 x 130 mm
- PAF. 15.77 75 x 175 mm
- PAF. 15.80 100 x 150 mm



- PAF. 21.16 165 x 90 x 35 mm
- PAF. 21.21 200 x 100 x 50 mm
- PAF. 21.23 230 x 130 x 50 mm
- PAF. 21.26 260 x 150 x 50 mm
- PAF. 21.30 305 x 205 x 50 mm

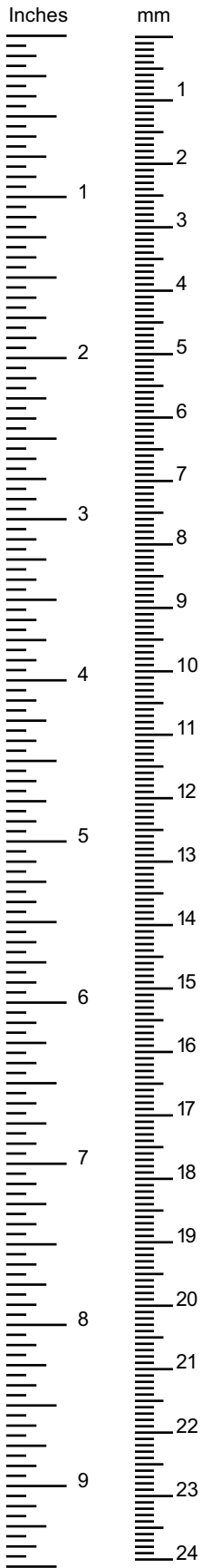

ORTHOPEDIC

Bandage scissors

Verbandscheren
Tijeras para vendajes
Ciseaux pour pansements

Cloth & plaster-of-paris shears

Kleiderstoff & Gipsscheren
Tijeras para vestidos y Cizallas para yesos
Cisailles pour pansements et pour appareils plâtres



Scissors with tungsten carbide cutting edges



Plaster cast spreaders, Plaster-of-Paris shears
 Gipsspreizer, Gipsscheren
 Pinzas y Cizallas para romper los vendajes enyesados
 Pincas et cisailles écartantes pour appareils plâtrés

Plaster-of-Paris knives & saw
 Gipsmesser, Gipssäge
 Cuchillos, Sierre de mano
 Couteaux, Scie à main

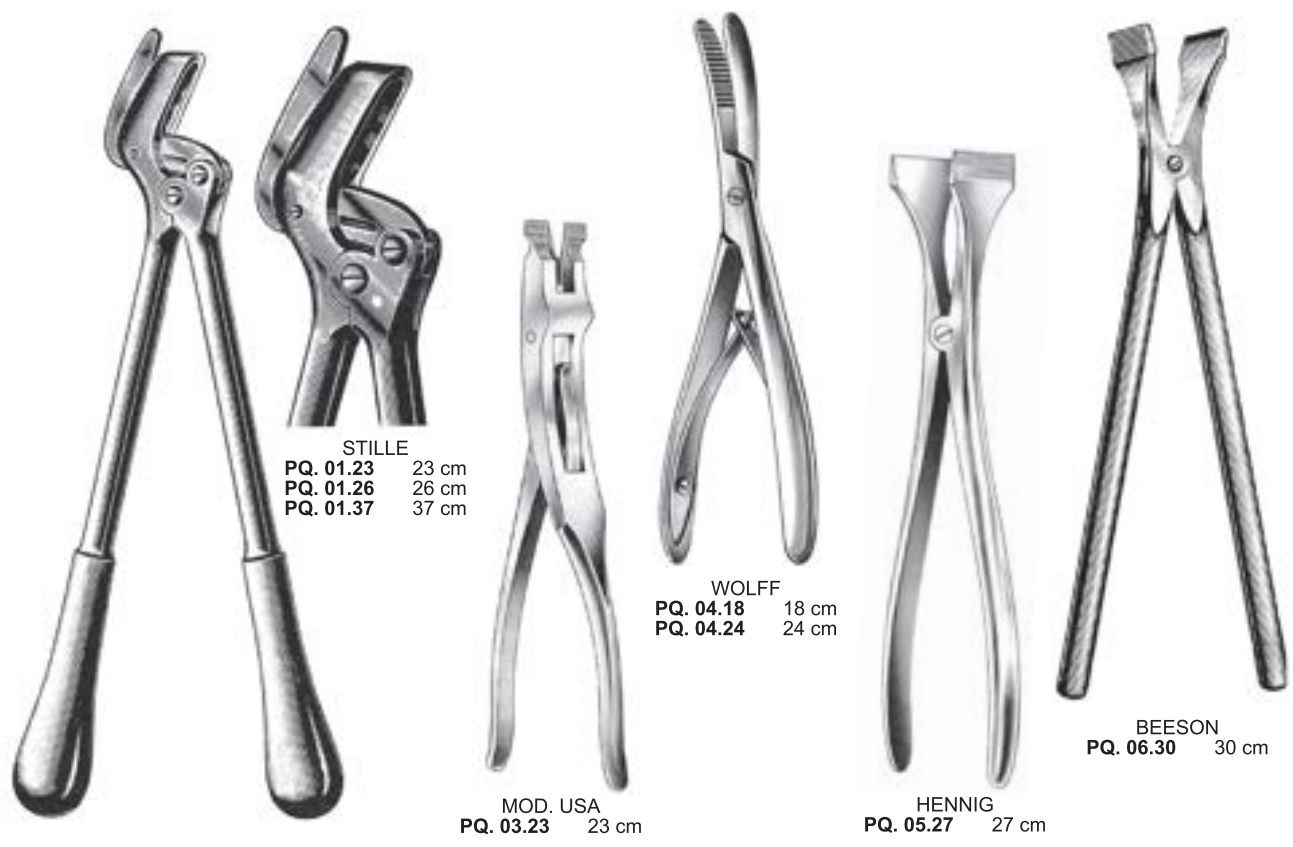

Mallets

Hämmer

Martillos y Mazos

Maillets



Ø 40 mm
690 g

KIRK
PM. 02.20 19.5 cm



Ø 42 mm Ø 30 mm
530 g

PM. 05.24 24 cm



Ø 26 mm
320 g

MEAD
PM. 06.19 17 cm



Ø 30 mm
400 g

GERZOG
PM. 07.18 18 cm



Ø 25 mm
140 g

PM. 08.18 18 cm



Ø 19 mm
215 g

PM. 09.19 19 cm

Mallets
 Hämmer
 Martillos y Mazos
 Maillets



450 g

PM. 17.26 26.5 cm



900 g

PM. 18.26 26.5 cm



ø 20 mm
140 g

THIESS
PM. 20.16 16 cm



PM. 21.19
ø 19 mm
230 g
PM. 21.25
ø 25 mm
260 g

LUCAE
19 cm



ø 22 mm
200 g

PARTSCH
PM. 22.18 18 cm



ø 27 mm
140 g

HAJEK
PM. 24.22 22 cm



ø 30 mm
220 g

COLLIN
PM. 25.20 20 cm

Mallets
 Hämmer
 Martillos y Mazos
 Maillets



PM. 27.30
 ø 26 mm
 300 g
PM. 27.34
 ø 28 mm
 340 g
PM. 27.40
 ø 30 mm
 400 g

WILLIGER
 24 cm



PM. 30.12
 ø 25 mm
 120 g
PM. 30.18
 ø 30 mm
 180 g
PM. 30.26
 ø 35 mm
 260 g

DOYEN
 20 cm



240 g

COTTLE
PM. 32.19 19 cm



300 g

BERGMANN
PM. 35.24 24 cm



300 g

BERGMANN
PM. 37.23 23 cm



550 g

OMBREDANNE
PM. 38.55 24 cm

Bone files, Rasps

Knochenfeilen, Raspeln

Limas para huesos, Escofinas

Limes à os, Râpes à os



PUTTI
PT. 04.28 28 cm



PUTTI
PT. 05.30 30 cm



PT. 06.22 22 cm



PT. 07.28 28 cm



PT. 08.24 24 cm



MILLER
PT. 10.30 18 cm

10



MILLER
PT. 10.40 18 cm

11



MILLER
PT. 10.45 18 cm

12



MILLER
PT. 10.50 18 cm

13



MILLER
PT. 10.55 18 cm

14

Elevators

Elevatorii
Elevadores
Elévateurs



WILLIGER
16 cm
PT. 12.04 4 mm



WILLIGER
16 cm
PT. 12.06 5.5 mm
PT. 12.07 7 mm



HOEN

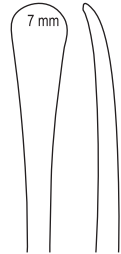

PT. 14.07
16 cm



PT. 14.15
19 cm

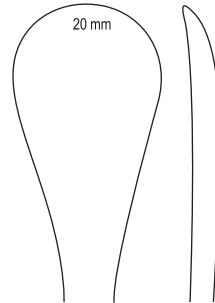

PT. 14.20
19 cm

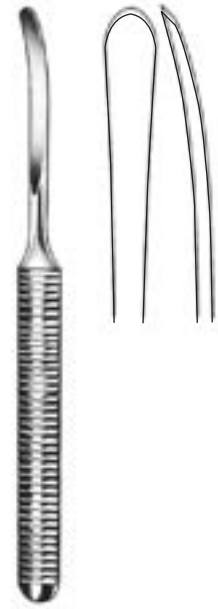

WILLIGER
16 cm
PT. 15.03 3 mm
PT. 15.05 5 mm
PT. 15.07 7 mm



McDONALD
PT. 18.19 19 cm



MOLT
PT. 19.18 18 cm



MOLT
PT. 19.19 18 cm



MOLT
PT. 19.20 18 cm



MOLT
PT. 19.21 18 cm



JOSEPH
PT. 22.16 16.5 cm

Elevators

Elevatori
Elevadores
Elévateurs

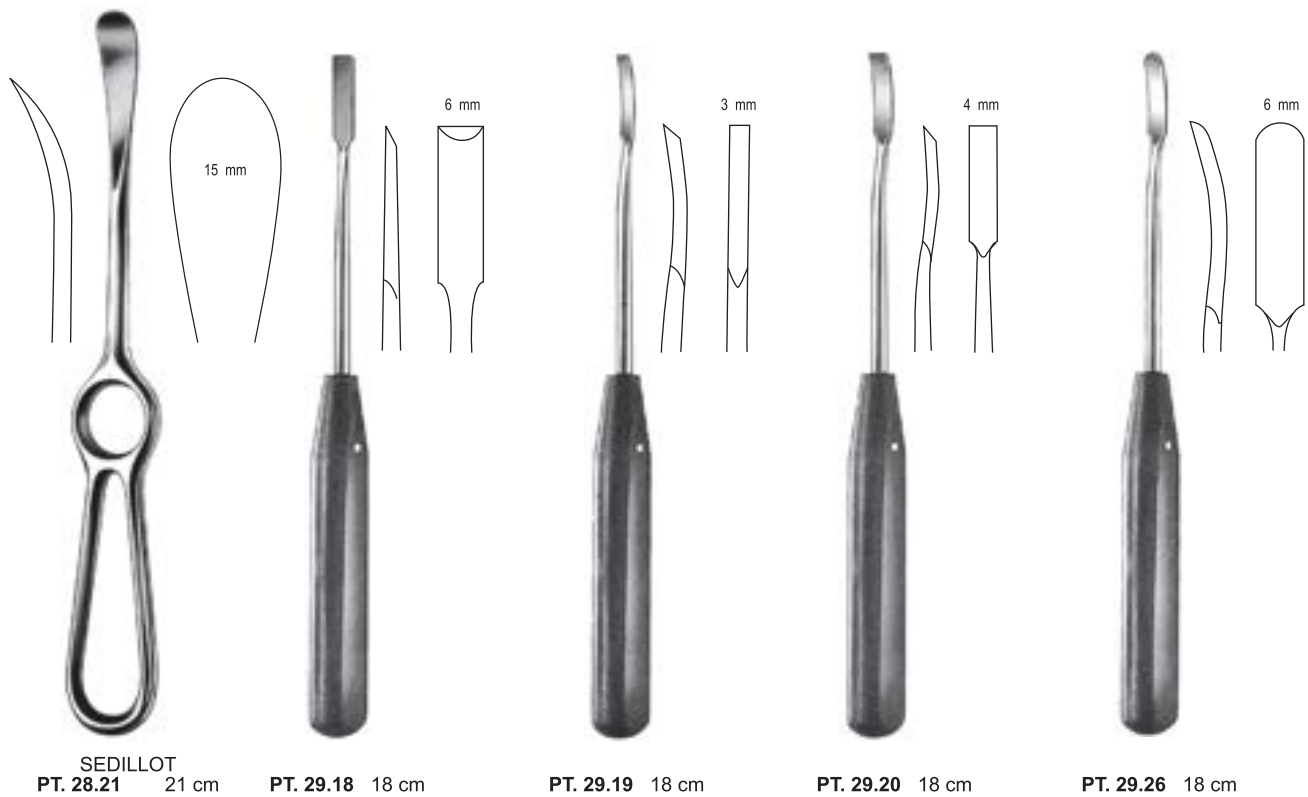
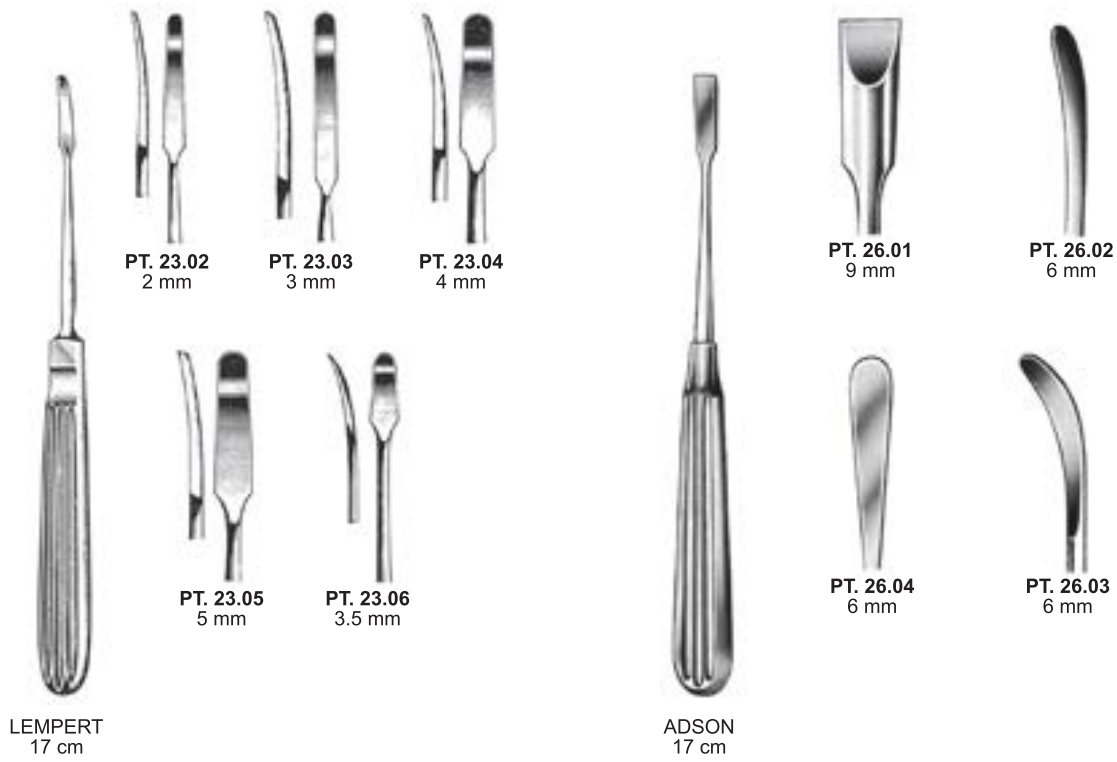

Raspatories
 Raspatorien
 Periostótomos
 Rugines



KIRMISSION
PT. 30.16 16.5 cm



SEMB



PT. 31.01
 12 mm
 20 cm

PT. 31.02
 12 mm
 24 cm

PT. 31.03
 14 mm
 20 cm

PT. 31.04
 14 mm
 24 cm

PT. 31.07
 16 mm
 24 cm



FARABEU
Straight **PT. 32.15** 15 cm
Curved **PT. 32.16**



PT. 33.20 19 cm



PT. 33.21 20 cm



PT. 33.22 20 cm



PT. 33.50 20 cm

Raspatories

Raspatorien
Periostótomos
Rugines

Elevators

Elevatorien
Elevadores
Elévateurs



LAMBOTTE
21 cm

- PT. 34.06 6 mm
- PT. 34.10 10 mm
- PT. 34.15 15 mm
- PT. 34.20 20 mm
- PT. 34.25 25 mm

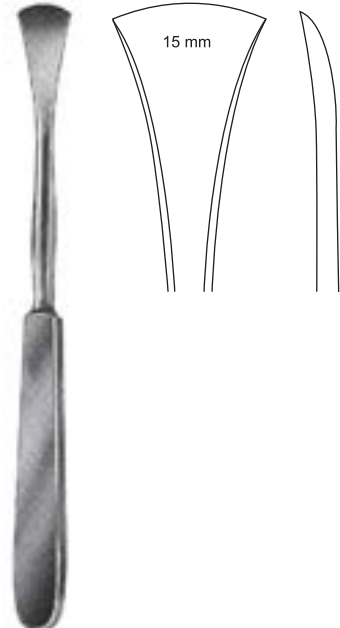

LANGENBECK
PT. 37.35 19 cm



LANGENBECK
PT. 37.63 18 cm

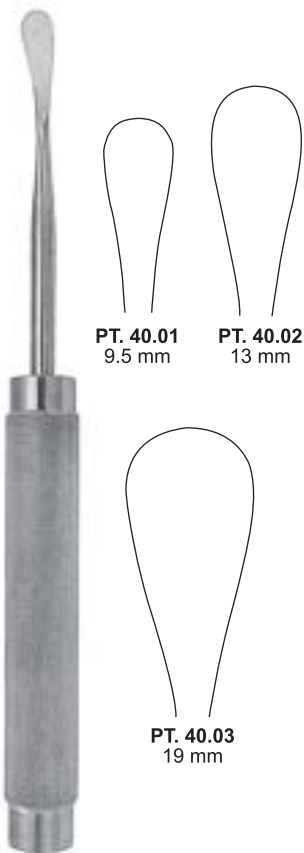

COBB
28 cm



ALDERDYCE
PT. 41.21 21 cm



FREER
PT. 42.18 18 cm

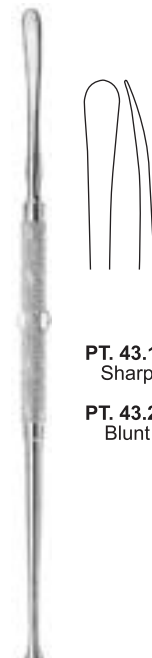

FREER
19 cm

PT. 43.19
Sharp

PT. 43.29
Blunt



PT. 44.18 17.5 cm



PT. 45.16 16 cm

Elevators

Elevatorien
Elevadores
Elévateurs

Raspatories

Raspatorien
Periostótomos
Rugines

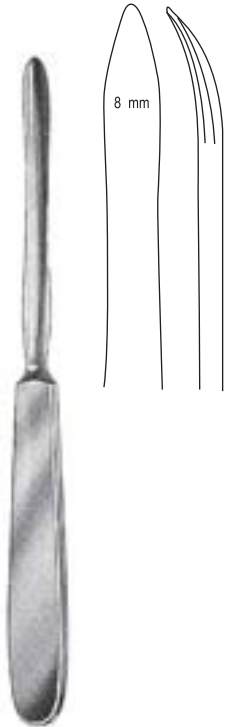

LANGENBECK
PT. 46.08 19.5 cm

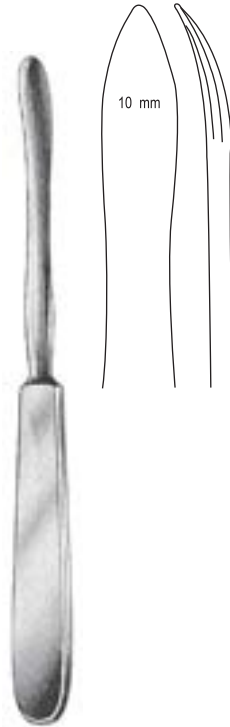

LANGENBECK
PT. 46.10 19.5 cm

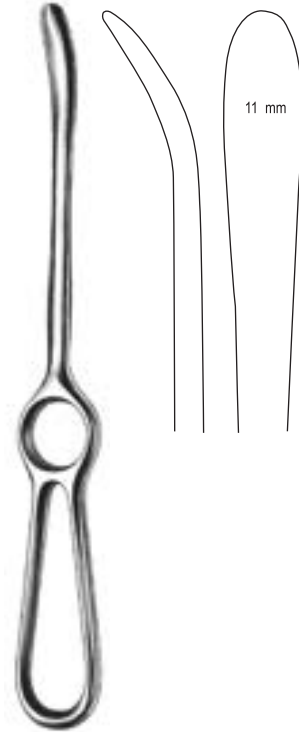

LANGENBECK
PT. 47.11 23 cm

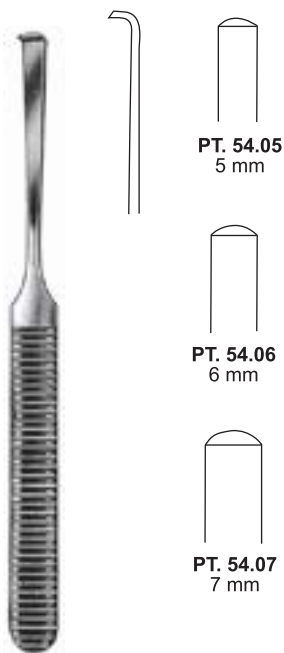

16 cm

PT. 54.05
5 mm

PT. 54.06
6 mm

PT. 54.07
7 mm



DOYEN
17 cm

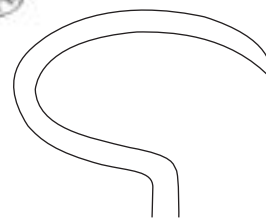

PAG. 46.11

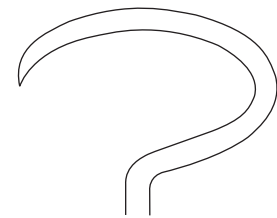

PAG. 46.12

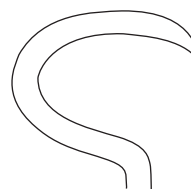

PAG. 46.21

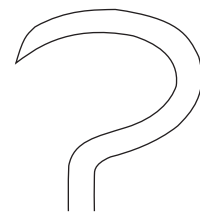

PAG. 46.22

Bone levers
 Knochenhebel
 Elevadores para huesos
 Levier à os

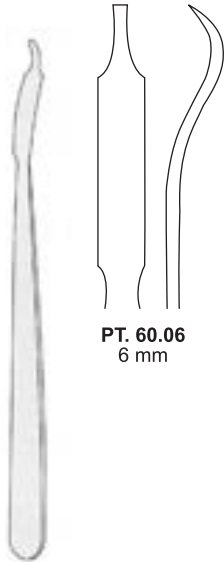

PT. 60.06
6 mm

MINI-HOHMANN
16 cm

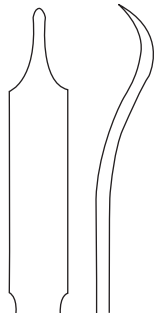

PT. 60.08
8 mm

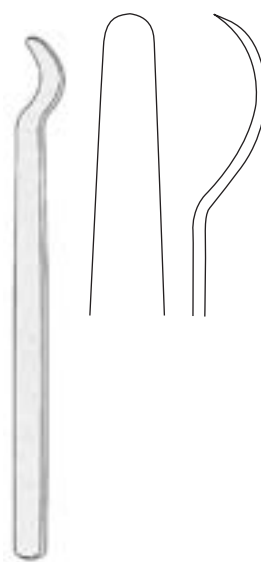

PT. 61.14
14 cm

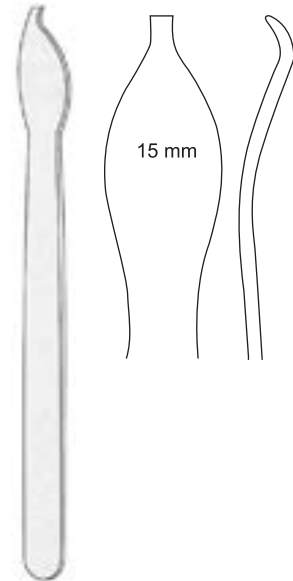

PT. 61.37
17 cm



HOHMANN
PT. 62.08 22 cm

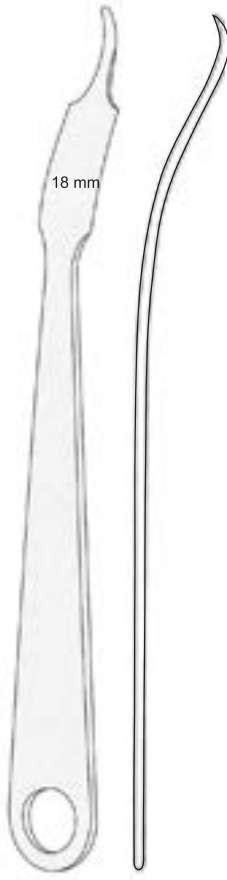

HOHMANN
PT. 62.18 24 cm

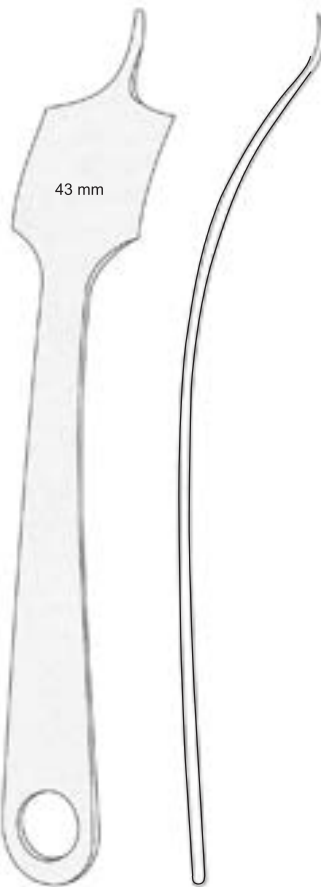

HOHMANN
PT. 62.43 26 cm

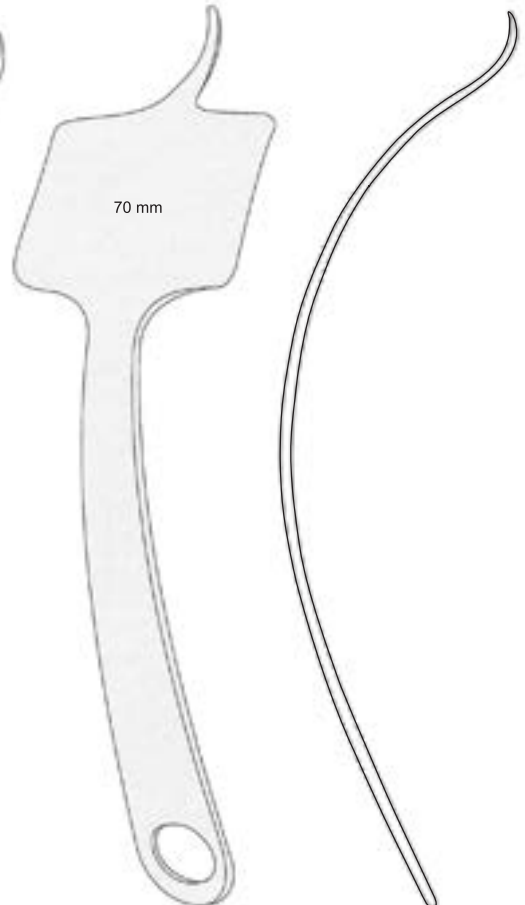

HOHMANN
PT. 62.70 29 cm

Bone levers
 Knochenhebel
 Elevadores para huesos
 Levier à os



Knee retractors

Wund-und Meniskushaken

Separadores para rodilla

Ecarteurs pour le genou

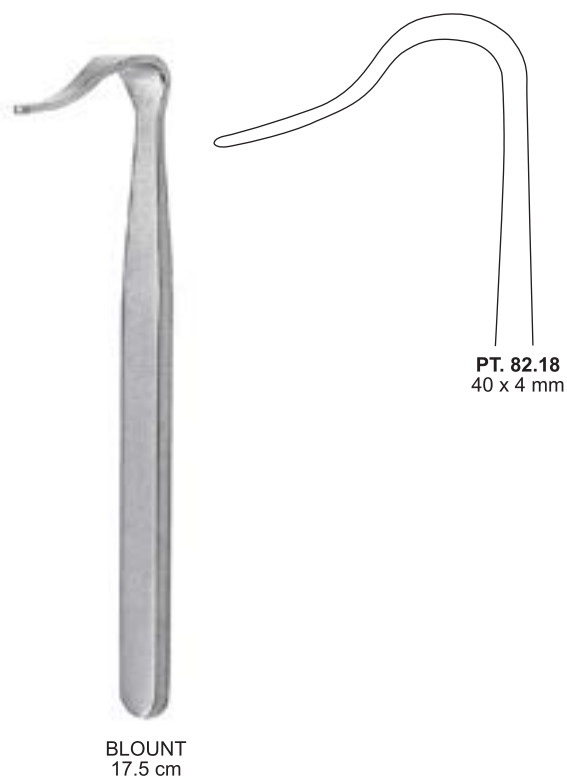
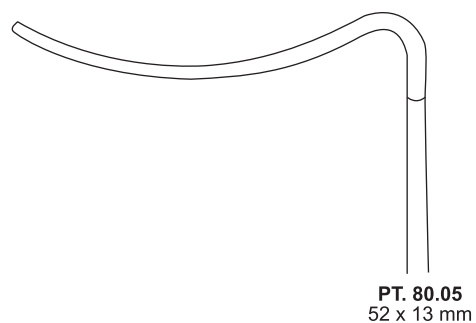
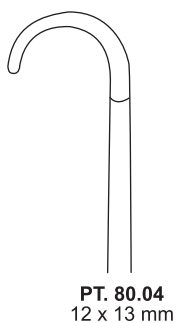
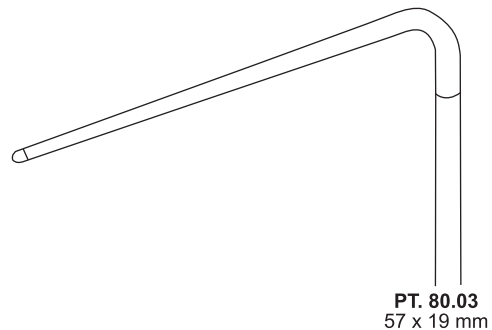
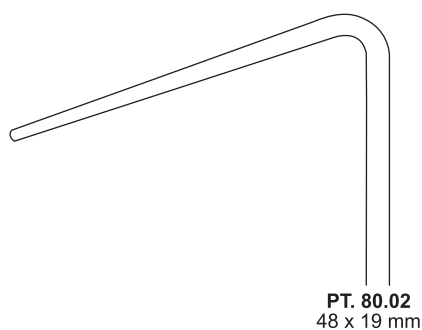
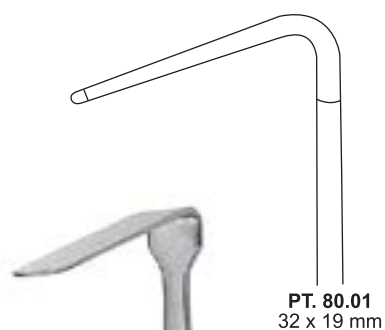

Bone cutting forceps

Knochensplitterzangen

Pinzas cortantes para huesos

Pincas coupantes

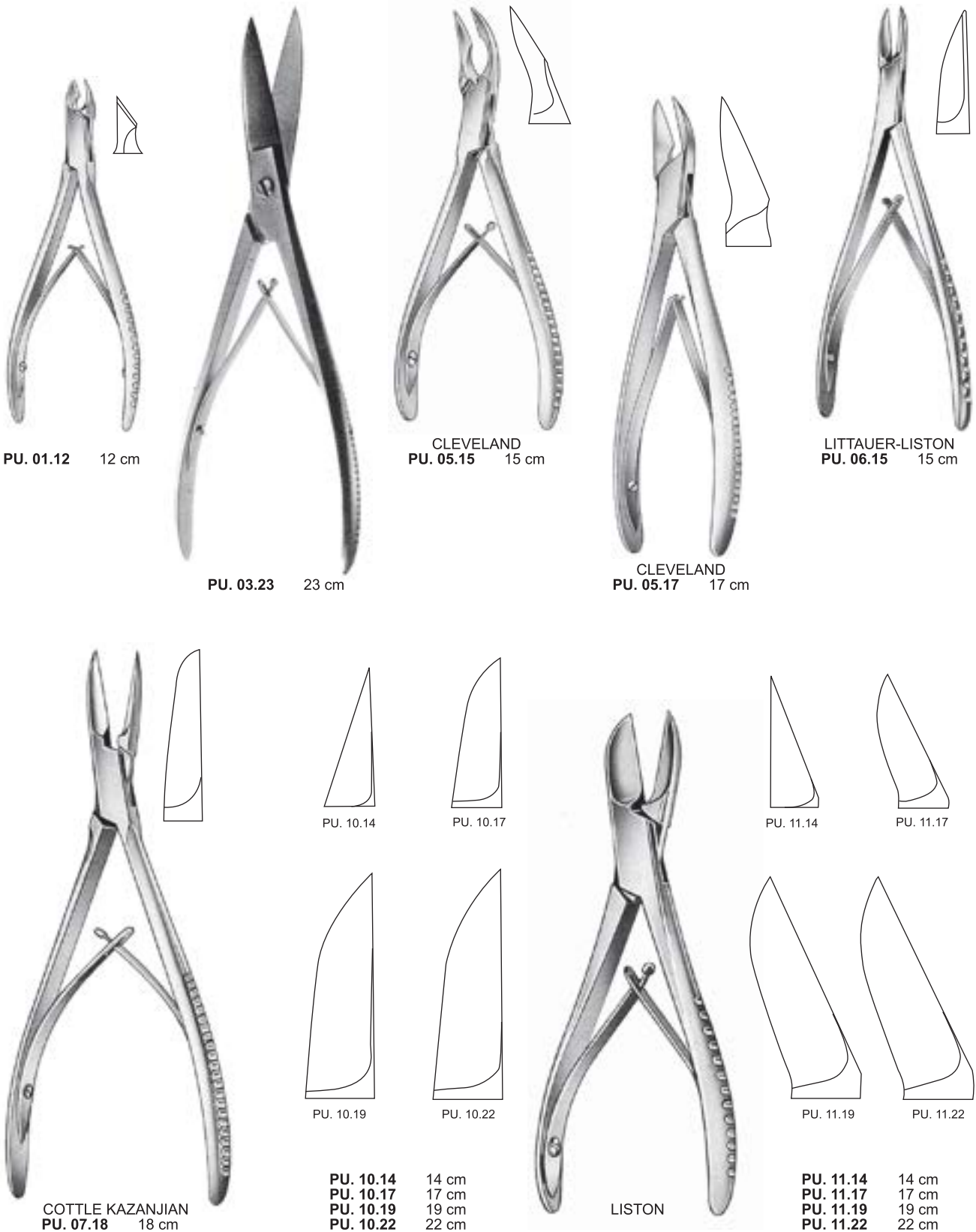

Bone cutting forceps

Knochensplitterzangen

Pinzas cortantes para huesos

Pinces coupantes



MCINDOE
Straight PU. 15.18 17.5 cm Angled PU. 15.19



LISTON-STILLE
PU. 17.27 27 cm

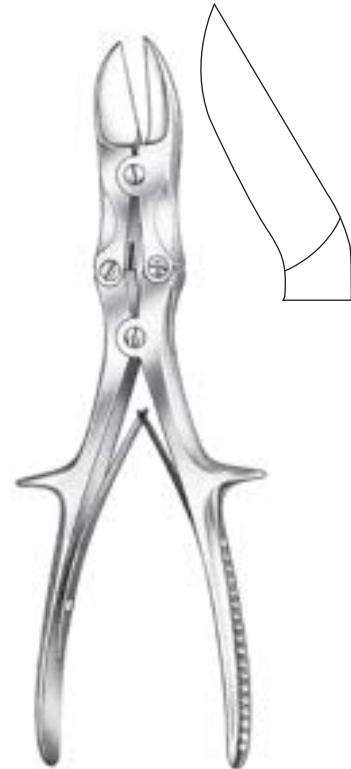

LISTON
Straight PU. 18.24 17.5 cm Angled PU. 18.25

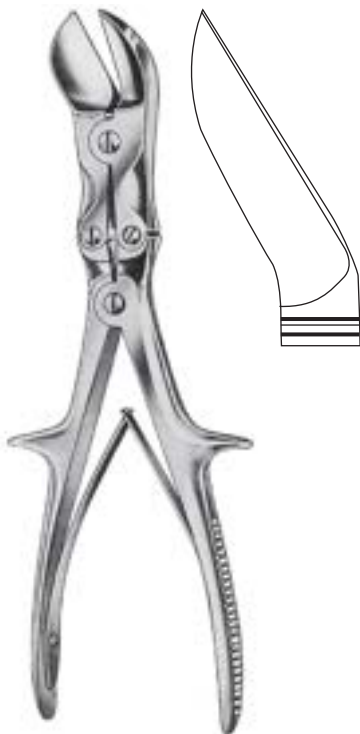

LISTON-STILLE
PU. 18.27 27 cm



LISTON-MINI
Straight PU. 20.15 15 cm Angled PU. 21.15



KLEINERT-KUTZ
PU. 22.15 15 cm

Bone cutting forceps

Knochensplitterzangen

Pinzas cortantes para huesos

Pinces coupantes



RUSKIN-ROWLAND
PU. 23.18 18 cm



RUSKIN-ROWLAND
PU. 24.18 18 cm



RUSKIN-LISTON
PU. 25.18 18 cm



RUSKIN-LISTON
PU. 26.18 18 cm



LISTON-KEY
(HORSLEY-STILLE)
PU. 28.27 27 cm



SEMB
PU. 29.23 23 cm

Bone holding forceps & clamps

Knochenhaltezaugen & -klammern

Pinzas para huesos y porte huesos

Daviers

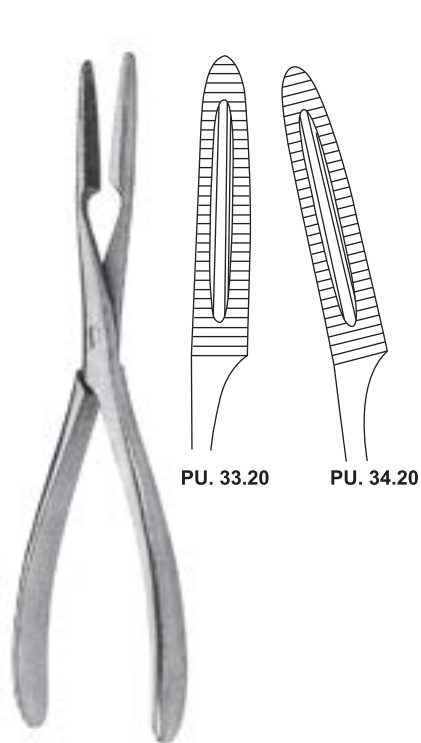

PU. 33.20

PU. 34.20

20 cm



VAN BUREN
PU. 35.23 23 cm



LOWMANN

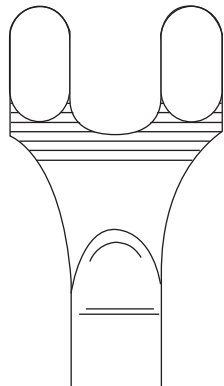

PU. 35.18 18 cm

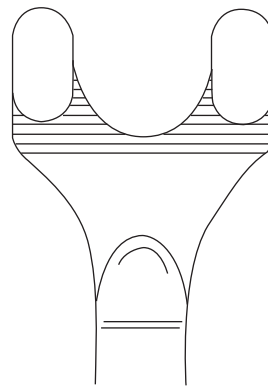

PU. 35.20 20 cm

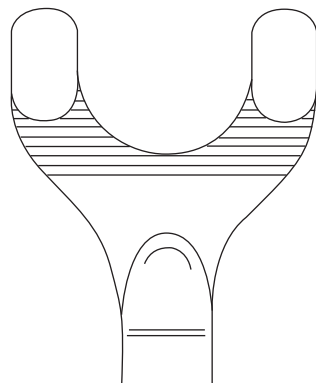

PU. 35.22 22 cm



PU. 36.20 20 cm

Bone holding forceps
 Knochenhaltezangen
 Pinzas para huesos
 Daviers

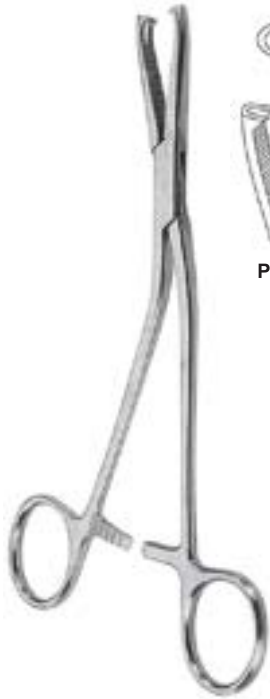

DINGMANN
19 cm

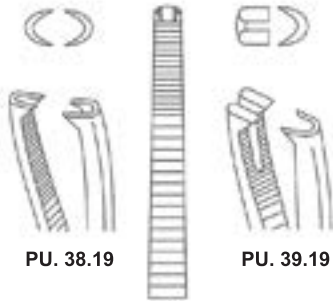

PU. 38.19

PU. 39.19



PU. 40.21 21 cm



PU. 41.16 16 cm

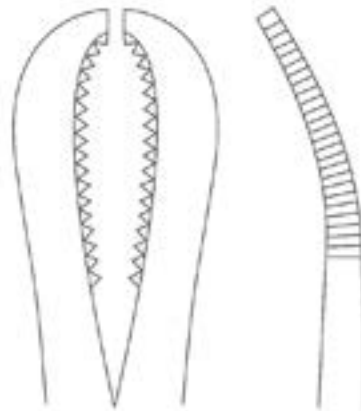
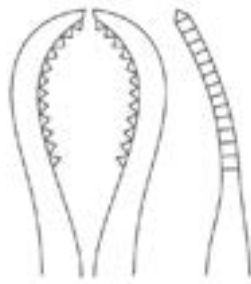

PU. 42.22 22 cm

Bone holding forceps
 Knochenhaltezangen
 Pinzas para huesos
 Daviers



SEMB
 PU. 43.20 20 cm



SEMB
 PU. 44.20 20 cm



PU. 46.14 13.5 cm



PU. 31.13 13.5 cm



LEWIN
 PU. 48.18 17.5 cm



MARTIN
 PU. 50.19 19 cm



LANGENBECK
 PU. 51.21 21 cm



FERGUSON
 PU. 52.21 21 cm

Bone holding forceps

Knochenhaltezangen

Pinzas para huesos

Daviers



ULRICH
PU. 55.23
PU. 55.25
PU. 55.28



PU. 55.23
PU. 55.24
23 cm



PU. 55.25
PU. 55.26
25 cm



PU. 55.28
PU. 55.29
28 cm



ULRICH
PU. 55.24
PU. 55.26
PU. 55.29

Bone holding forceps

Knochenhaltezaugen

Pinzas para huesos

Daviers



KERN
PU. 56.14 14 cm
PU. 56.17 17 cm
PU. 61.23 23 cm



KERN
PU. 57.14 14 cm
PU. 57.17 17 cm
PU. 60.23 23 cm



LANE
 Without Ratchet **PU. 58.33** 33 cm
 With Ratchet **PU. 59.33** 33 cm
PU. 58.45 45 cm **PU. 59.45** 45 cm



LAMBOTTE
PU. 62.21 21 cm
PU. 62.25 25 cm
PU. 62.30 30 cm



LAMBOTTE
PU. 63.21 21 cm
PU. 63.26 26 cm
PU. 63.33 30 cm



FARABEUF
PU. 64.25 25 cm



FARABEUF-LAMBOTTE
PU. 65.26 26 cm

Bone holding forceps
 Knochenhaltezangen
 Pinzas para huesos
 Daviers



VERBRUGGE



PU. 66.17 17.5 cm

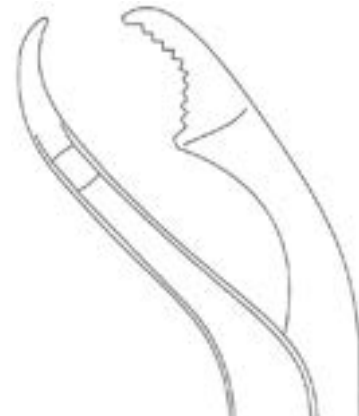

PU. 67.25 25 cm



PU. 67.26 26 cm



LAMBOTTE
 PU. 68.19 19 cm
 PU. 68.23 23 cm
 PU. 62.26 26 cm

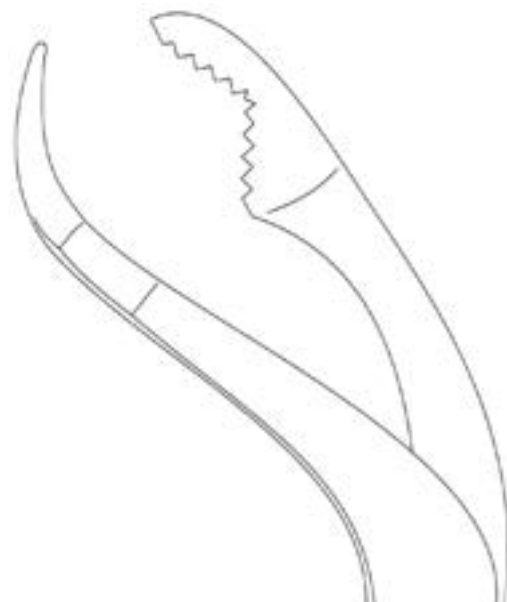
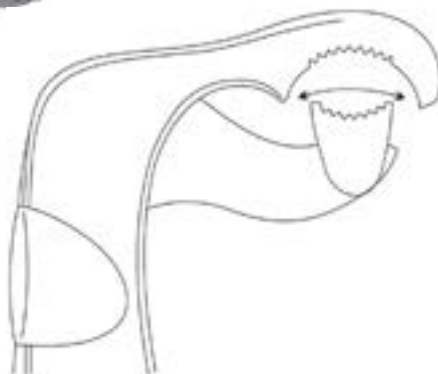

PU. 67.27 27 cm

Bone holding forceps

Knochenhalte­zangen

Pinzas para huesos

Daviers



PU. 69.15 15 cm



PU. 69.19 19 cm



PU. 69.24 24 cm



PU. 69.26 26 cm



PU. 69.28 28 cm

Amputating & resection saws

Amputations- & Resektionssägen

Sierras para amputación y resección

Scies à amputation et résection

Wire saws, Extension bows

Drahtsägen, Extensionsbügel

Sierras de hilo metálico, Estribos para extensión

Fils scies, Extries à extension



LANGENBECK
PU. 70.30 23 cm



CHARRIERE
PU. 71.27 27 cm
PU. 71.30 30 cm
PU. 71.34 34 cm



SATTERLEE
PU. 72.29 31 cm



CHARRIERE
PU. 73.35 35 cm



GIGLI
PU. 74.30 30 cm
PU. 74.40 40 cm
PU. 74.50 50 cm
PU. 74.60 60 cm
PU. 74.70 70 cm



GIGLI
PU. 74.02

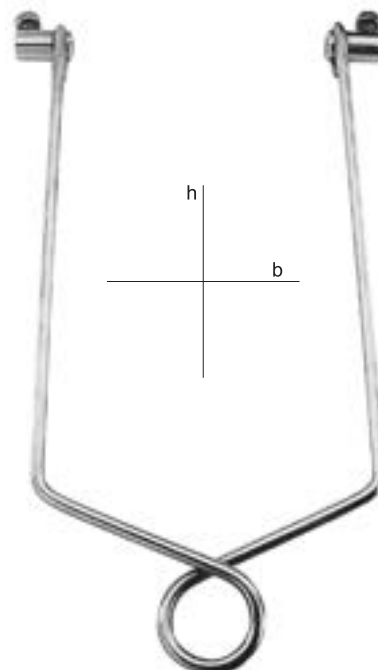

BÖHLER
h x b
PU. 76.01 16 x 9 cm
PU. 76.03 21 x 11 cm
PU. 76.05 21 x 15 cm

Wire forceps

Drahtzangen
Pinzas para hilos
Pincas à fil

Flat nose pliers, Wire twisting instruments

Flachzangen, Drahtspanninstrumente
Alicates planos, Tensores cierra-hilos
Pincas plates, Tendeurs serre-fils

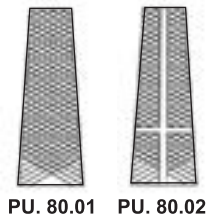

PU. 80.01 PU. 80.02

17 cm



PU. 82.15
15 cm

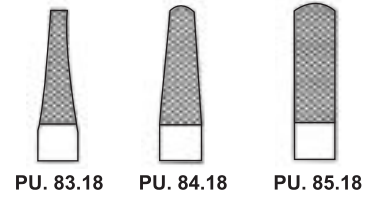

PU. 83.18 PU. 84.18 PU. 85.18

18 cm

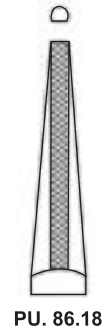

PU. 86.18



PU. 88.18 18 cm



PU. 89.17 17 cm



LOUTE
PU. 90.21 21 cm

Wire cutting pliers
 Drahtkneifzangen
 Alicates cortaalambres
 Pincès coupe-fil

Wire cutting pliers, PROLONG TC®
 Drahtkneifzangen, **PROLONG TC®**
 Alicates cortaalambres, **PROLONG TC®**
 Pincès coupe-fil, **PROLONG TC®**

Scissors with tungsten carbide cutting edges



UNIVERSAL
 PS. 23.12 12 cm



For hard wires upto
 ø 0.8 mm
 For soft wires upto
 ø 1.2 mm

UNIVERSAL
 PS. 24.12 12 cm

Pliers with tungsten carbide cutting edges



PU. 91.15 15 cm



PU. 92.16 16 cm

For hard wires upto
 ø 1.5 mm
 For soft wires upto
 ø 2.0 mm



PU. 94.18 18 cm

Wire cutting pliers, PROLONG TC®
 Drahtkneifzangen, **PROLONG TC®**
 Alicates cortaalambres, **PROLONG TC®**
 Pincas coupe-fil, **PROLONG TC®**

Pliers with tungsten carbide cutting edges

PU. 100.47
 For cutting off
 KIRCHNER wires,
 TIBIA head screw,
 bolts, pins upto
 ø 6.0 mm

PU. 100.56
PROLONG TC®
 For hard wires upto
 ø 2.5 mm

For hard wires upto
 ø 2.5 mm

For hard wires upto
 ø 1.6 mm

For soft wires upto
 ø 2.0 mm



PU. 96.17 17 cm



PU. 98.22 22 cm



MEGA CUT
PU. 100.47 47 cm
PU. 100.56 56 cm

Chisels & Gouges

Flach- & Hohlmeißel

Cinceles y Gubias

Ciseaux-burins et Gouges



MINI-LAMBOTTE
13 cm

PV. 01.02	2 mm
PV. 01.04	4 mm
PV. 01.06	6 mm
PV. 01.08	8 mm
PV. 01.10	10 mm
PV. 01.12	12 mm
PV. 01.15	15 mm



TRAUTMANN
11 cm

PV. 04.12	2 mm
PV. 04.14	4 mm
PV. 04.16	6 mm
PV. 04.18	8 mm
PV. 04.20	10 mm



TRAUTMANN
11 cm

PV. 04.72	2 mm
PV. 04.74	4 mm
PV. 04.76	6 mm
PV. 04.78	8 mm
PV. 04.80	10 mm



13.5 cm

PV. 05.02	
PV. 05.03	
PV. 05.04	
PV. 05.05	
PV. 05.06	
PV. 05.07	
PV. 05.08	

17 cm

PV. 05.52	2 mm
PV. 05.53	3 mm
PV. 05.54	4 mm
PV. 05.55	5 mm
PV. 05.56	6 mm
PV. 05.57	7 mm
PV. 05.58	8 mm



13.5 cm

PV. 06.02	PV. 06.52
PV. 06.03	PV. 06.53
PV. 06.04	PV. 06.54
PV. 06.05	PV. 06.55
PV. 06.06	PV. 06.56
PV. 06.07	PV. 06.57
PV. 06.08	PV. 06.58

17 cm



HOKE
14 cm

PV. 13.03	3 mm
PV. 13.04	5 mm
PV. 13.06	6 mm
PV. 13.08	8 mm
PV. 13.10	10 mm
PV. 13.12	12 mm



PV. 11.06	6 mm
PV. 11.08	8 mm
PV. 11.10	10 mm
PV. 11.12	12 mm
PV. 11.15	15 mm
PV. 11.20	20 mm
PV. 11.25	25 mm
PV. 11.30	30 mm



PV. 12.06	6 mm
PV. 12.08	8 mm
PV. 12.10	10 mm
PV. 12.12	12 mm
PV. 12.15	15 mm
PV. 12.20	20 mm
PV. 12.25	25 mm
PV. 12.30	30 mm



STILLE
20 cm

PV. 16.08	8 mm
PV. 16.10	10 mm
PV. 16.12	12 mm
PV. 16.15	15 mm
PV. 16.20	20 mm
PV. 16.25	25 mm



PV. 16.58	8 mm
PV. 16.60	10 mm
PV. 16.62	12 mm
PV. 16.65	15 mm
PV. 16.70	20 mm
PV. 16.75	25 mm

Chisels, Gouges and Osteotomes

Meißel und Osteotome

Cinceles, Gubias, Osteótomos

Ciseaux-Burins, Cinceles e Osteótomos



ALEXANDER
18 cm

- PV. 17.04 4 mm
- PV. 17.06 6 mm
- PV. 17.08 8 mm
- PV. 17.10 10 mm
- PV. 17.12 12 mm
- PV. 17.14 14 mm



ALEXANDER
18 cm

- PV. 18.04 4 mm
- PV. 18.06 6 mm
- PV. 18.08 8 mm
- PV. 18.10 10 mm
- PV. 18.12 12 mm
- PV. 18.14 14 mm



STILLE
16 cm

- PV. 19.06 6 mm
- PV. 19.08 8 mm
- PV. 19.10 10 mm
- PV. 19.12 12 mm
- PV. 19.15 15 mm



STILLE
16 cm

- PV. 20.04 4 mm
- PV. 20.06 6 mm
- PV. 20.08 8 mm
- PV. 20.10 10 mm
- PV. 20.12 12 mm
- PV. 20.15 15 mm



13.5 cm

- PV. 23.03 3 mm
- PV. 23.04 4 mm
- PV. 23.06 6 mm
- PV. 23.08 8 mm
- PV. 23.10 10 mm
- PV. 23.12 12 mm
- PV. 23.14 14 mm
- PV. 23.16 16 mm



13.5 cm

- PV. 24.03 3 mm
- PV. 24.04 4 mm
- PV. 24.06 6 mm
- PV. 24.08 8 mm
- PV. 24.10 10 mm
- PV. 24.12 12 mm
- PV. 24.14 14 mm
- PV. 24.16 16 mm



13.5 cm

- PV. 25.04 4 mm
- PV. 25.06 6 mm
- PV. 25.08 8 mm
- PV. 25.10 10 mm
- PV. 25.12 12 mm
- PV. 25.14 14 mm
- PV. 25.16 16 mm

Chisels, Gouges and Osteotomes

Meißel und Osteotome

Cinceles, Gubias y Osteótomos

Ciseaux-Burins, Gouges et Ostéotomes



HIBBS
24 cm

- PV. 30.06 6 mm
- PV. 30.13 13 mm
- PV. 30.19 19 mm
- PV. 30.25 25 mm
- PV. 30.32 32 mm
- PV. 30.40 40 mm



HIBBS
24 cm

- PV. 31.06 6 mm
- PV. 31.13 13 mm
- PV. 31.19 19 mm
- PV. 31.25 25 mm
- PV. 31.32 32 mm
- PV. 31.40 40 mm



HIBBS
24 cm

- PV. 32.06 6 mm
- PV. 32.13 13 mm
- PV. 32.19 19 mm
- PV. 32.25 25 mm
- PV. 32.32 32 mm
- PV. 32.40 40 mm



HIBBS
24 cm

- PV. 33.06 6 mm
- PV. 33.13 13 mm
- PV. 33.19 19 mm
- PV. 33.25 25 mm
- PV. 33.32 32 mm
- PV. 33.40 40 mm



HIBBS
24 cm

- PV. 33.56 6 mm
- PV. 33.53 13 mm
- PV. 33.59 19 mm
- PV. 33.65 25 mm
- PV. 33.72 32 mm
- PV. 33.80 40 mm



LUCAS
16 cm

- PV. 35.04 4 mm
- PV. 35.06 6 mm
- PV. 35.08 8 mm
- PV. 35.10 10 mm



LUCAS
16 cm

- PV. 35.34 4 mm
- PV. 35.36 6 mm
- PV. 35.38 8 mm
- PV. 35.40 10 mm

Gouges
 Hohlmeißel
 Gubias
 Gouges



4 mm

COBB
 PV. 36.91 28 cm



4 mm

COBB
 PV. 36.92 28 cm



4 mm

COBB
 PV. 36.93 28 cm



4 mm

COBB
 PV. 36.94 28 cm



LEXER
 25 cm

- PV. 36.55 5 mm
- PV. 36.60 10 mm
- PV. 36.65 15 mm



LEXER
 25 cm

- PV. 36.75 5 mm
- PV. 36.80 10 mm
- PV. 36.85 15 mm

Chisels & Gouges

Flach- & Hohlmeißel

Cinceles y Gubias

Ciseaux-burins et Gouges



- PV. 38.06 6 mm
- PV. 38.09 9 mm
- PV. 38.12 12 mm
- PV. 38.14 14 mm
- PV. 38.15 15 mm
- PV. 38.20 20 mm
- PV. 38.25 25 mm
- PV. 38.30 30 mm



- PV. 38.56 6 mm
- PV. 38.59 9 mm
- PV. 38.62 12 mm
- PV. 38.64 14 mm
- PV. 38.65 15 mm
- PV. 38.70 20 mm
- PV. 38.75 25 mm
- PV. 38.82 30 mm



- PV. 40.06 6 mm
- PV. 40.09 9 mm
- PV. 40.12 12 mm
- PV. 40.15 15 mm
- PV. 40.16 16 mm
- PV. 40.17 17 mm
- PV. 40.20 20 mm
- PV. 40.25 25 mm
- PV. 40.30 30 mm



- PV. 40.56 6 mm
- PV. 40.59 9 mm
- PV. 40.62 12 mm
- PV. 40.64 14 mm
- PV. 40.65 15 mm
- PV. 40.66 16 mm
- PV. 40.70 20 mm
- PV. 40.75 25 mm
- PV. 40.80 30 mm

SMITH-PETERSEN
20 cm



LAMBOTTE
24 cm

- PV. 39.04 4 mm
- PV. 39.06 6 mm
- PV. 39.08 8 mm
- PV. 39.10 10 mm
- PV. 39.12 12 mm
- PV. 39.15 15 mm
- PV. 39.20 20 mm
- PV. 39.25 25 mm
- PV. 39.30 30 mm
- PV. 39.38 38 mm
- PV. 39.40 40 mm
- PV. 39.44 44 mm
- PV. 39.50 50 mm



LAMBOTTE
24 cm

- PV. 39.54 4 mm
- PV. 39.56 6 mm
- PV. 39.58 8 mm
- PV. 39.60 10 mm
- PV. 39.62 12 mm
- PV. 39.65 15 mm
- PV. 39.70 20 mm
- PV. 39.75 25 mm
- PV. 39.80 30 mm
- PV. 39.88 38 mm
- PV. 39.90 40 mm
- PV. 39.94 44 mm
- PV. 39.99 50 mm

Chisels & Gouges

Flach- & Hohlmeißel

Cinceles y Gubias

Ciseaux-burins et Gouges



DAHMEN
30 cm

4 mm
5 mm
6 mm
8 mm
10 mm
12 mm
15 mm
20 mm
22 mm
25 mm



PV. 45.04
PV. 45.05
PV. 45.06
PV. 45.08
PV. 45.10
PV. 45.12
PV. 45.15
PV. 45.20
PV. 45.22
PV. 45.25

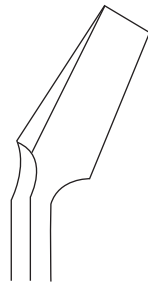

PV. 46.04
PV. 46.05
PV. 46.06
PV. 46.08
PV. 46.10
PV. 46.12
PV. 46.15
PV. 46.20
PV. 46.22
PV. 46.25



PV. 47.04
PV. 47.05
PV. 47.06
PV. 47.08
PV. 47.10
PV. 47.12
PV. 47.15
PV. 47.20
PV. 47.22
PV. 47.25

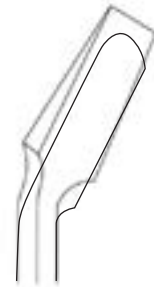

PV. 48.04
PV. 48.05
PV. 48.06
PV. 48.08
PV. 48.10
PV. 48.12
PV. 48.15
PV. 48.20
PV. 48.22
PV. 48.25



LEXER
27.5 cm

PV. 50.10 10 mm
PV. 50.15 15 mm



LEXER
27.5 cm

PV. 52.10 10 mm
PV. 52.15 15 mm

Chisels, Gouges and Osteotomes

Meißel und Osteotome

Cinceles y Gubias

Ciseaux-Burins et Ostéotomes

Meniscotomy knives

Meniskotome

Bisturies para meniscos

Bistouris à ménisques



MINI-LEXER
18 cm

- PV. 54.04 4 mm
- PV. 54.06 6 mm
- PV. 54.08 8 mm
- PV. 54.10 10 mm
- PV. 54.12 12 mm
- PV. 54.15 15 mm
- PV. 54.20 20 mm



MINI-LEXER
18 cm

- PV. 56.04 4 mm
- PV. 56.06 6 mm
- PV. 56.08 8 mm
- PV. 56.10 10 mm
- PV. 56.12 12 mm
- PV. 56.15 15 mm
- PV. 56.20 20 mm



LEXER
22 cm

- PV. 58.07 7 mm
- PV. 58.10 10 mm
- PV. 58.15 15 mm
- PV. 58.20 20 mm
- PV. 58.25 25 mm
- PV. 58.30 30 mm



LEXER
22 cm

- PV. 60.07 7 mm
- PV. 60.10 10 mm
- PV. 60.15 15 mm
- PV. 60.20 20 mm
- PV. 60.25 25 mm
- PV. 60.30 30 mm



SMILLIE
17 cm



PV. 62.01

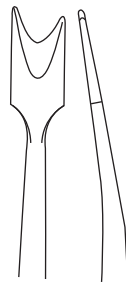

PV. 62.02

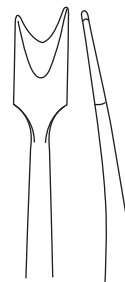

PV. 62.03

Bone curettes
 Scharfe Löffel
 Cucharillas cortantes
 Curettes tranchantes



BRUNS
17 cm

Fig. 000
PW. 03.33

Fig. 00
PW. 03.42

Fig. 0
PW. 03.50

Fig. 1
PW. 03.51

Fig. 2
PW. 03.52

Fig. 3
PW. 03.53

Fig. 4
PW. 03.54

Fig. 5
PW. 03.55

Fig. 6
PW. 03.56



BRUNS
23 cm

Fig. 0000
PW. 09.24

Fig. 000
PW. 09.33

Fig. 00
PW. 09.42

Fig. 0
PW. 09.50

Fig. 1
PW. 09.51

Fig. 2
PW. 09.52

Fig. 3
PW. 09.53

Fig. 4
PW. 09.54

Fig. 5
PW. 09.55

Fig. 6
PW. 09.56

Bone curettes

Scharfe Löffel
Cucharillas cortantes
Curettes tranchantes

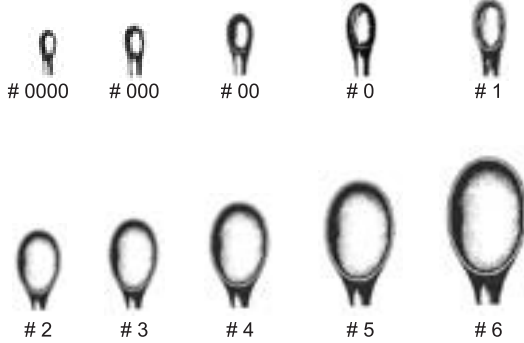

PW. 10.24 # 0000
PW. 10.33 # 000
PW. 10.42 # 00
PW. 10.50 # 0
PW. 10.51 # 1
PW. 10.52 # 2
PW. 10.53 # 3
PW. 10.54 # 4
PW. 10.55 # 5
PW. 10.56 # 6

BRUNS
(VOLKMANN)
27 cm
Silver Handle

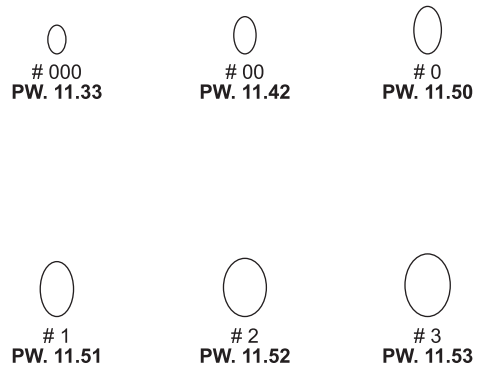

000 PW. 11.33 # 00 PW. 11.42 # 0 PW. 11.50

1 PW. 11.51 # 2 PW. 11.52 # 3 PW. 11.53

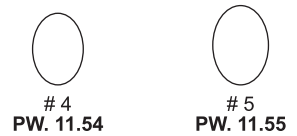

4 PW. 11.54 # 5 PW. 11.55

SPRATT
17 cm

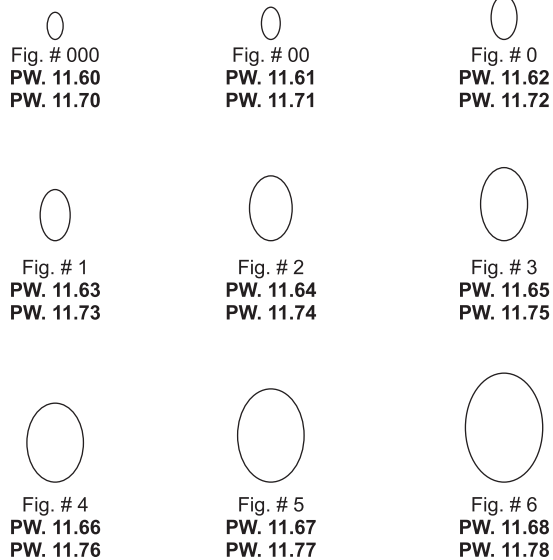

Fig. # 000 PW. 11.60 PW. 11.70 Fig. # 00 PW. 11.61 PW. 11.71 Fig. # 0 PW. 11.62 PW. 11.72

Fig. # 1 PW. 11.63 PW. 11.73 Fig. # 2 PW. 11.64 PW. 11.74 Fig. # 3 PW. 11.65 PW. 11.75

Fig. # 4 PW. 11.66 PW. 11.76 Fig. # 5 PW. 11.67 PW. 11.77 Fig. # 6 PW. 11.68 PW. 11.78

PW. 11.60 - PW. 11.68

HIBBS SPRATT
SPINAL FUSION
25.5 cm

PW. 11.70 - PW. 11.78

Bone curettes

Scharfe Löffel

Cucharillas cortantes

Curettes tranchantes



HALLE
21 cm

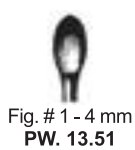

Fig. # 1 - 4 mm
PW. 13.51



Fig. # 2 - 5 mm
PW. 13.52



Fig. # 3 - 6 mm
PW. 13.53



VOLKMANN
17 cm



Fig. # 0000
PW. 14.24



Fig. # 000
PW. 14.33



Fig. # 00
PW. 14.42



Fig. # 0
PW. 14.50



Fig. # 1
PW. 14.51



Fig. # 2
PW. 14.52



Fig. # 3
PW. 14.53



Fig. # 4
PW. 14.54

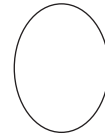

Fig. # 5
PW. 14.55



Fig. # 6
PW. 14.56



SCHEDE
17 cm



Fig. # 000
PW. 15.33



Fig. # 00
PW. 15.42



Fig. # 0
PW. 15.50



Fig. # 1
PW. 15.51



Fig. # 2
PW. 15.52



Fig. # 3
PW. 15.53



Fig. # 4
PW. 15.54

Bone curettes

Scharfe Löffel
Cucharillas cortantes
Curettes tranchantes



PW. 16.24 - PW. 16.56

Fig. # 0000
PW. 16.24
PW. 17.24

Fig. # 000
PW. 16.33
PW. 17.33

Fig. # 00
PW. 16.42
PW. 17.42

Fig. # 0
PW. 16.50
PW. 17.50

Fig. # 1
PW. 16.51
PW. 17.51

Fig. # 2
PW. 16.52
PW. 17.52

Fig. # 3
PW. 16.53
PW. 17.53

Fig. # 4
PW. 16.54
PW. 17.54

Fig. # 5
PW. 16.55
PW. 17.55

Fig. # 6
PW. 16.56
PW. 17.56

BRUNS-VOLKMANN
23 cm



PW. 17.24 - PW. 17.56



MARTINI
13.5 cm

PW. 18.10

PW. 18.11

PW. 18.12



JANSEN
PW. 19.62
17 cm



PW. 20.96
21 cm



WILLIGER
13.5 cm

PW. 21.10

PW. 21.11

PW. 21.12

Bone curettes

Scharfe Löffel

Cucharillas cortantes

Curettes tranchantes



JANSEN
PW. 23.72
17 cm



VOLKMANN

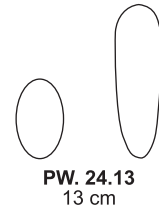

PW. 24.13
13 cm

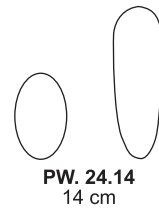

PW. 24.14
14 cm

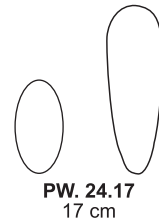

PW. 24.17
17 cm



VOLKMANN
22 cm



Fig. # 1
PW. 25.01



Fig. # 2
PW. 25.02



Fig. # 3
PW. 25.03



VOLKMANN

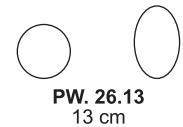

PW. 26.13
13 cm

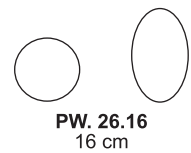

PW. 26.16
16 cm

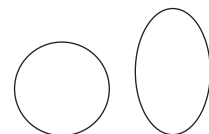

PW. 26.20
20 cm

Bone rongeurs
 Hohlmeißelzangen
 Pinzas Gubias
 Pincas gouges



MINI-FRIEDMAN
PX. 01.12
 12 cm



FRIEDMAN
PX. 01.14
 14 cm

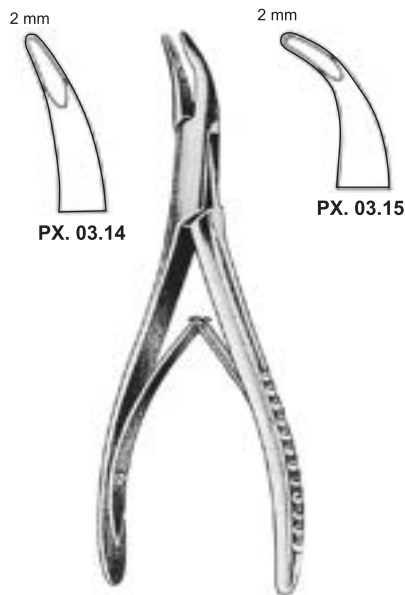

PX. 03.14

PX. 03.15

14 cm



UNIVERSAL
PX. 03.84
 13 cm



MEAD
PX. 04.14
 14 cm



MEAD
PX. 04.17
 17 cm

Bone rongeurs
 Hohlmeißelzangen
 Pinzas Gubias
 Pincas gouges



HARTMANN
PX. 08.66
 18 cm



OLIVECRONA
PX. 09.69
 20 cm

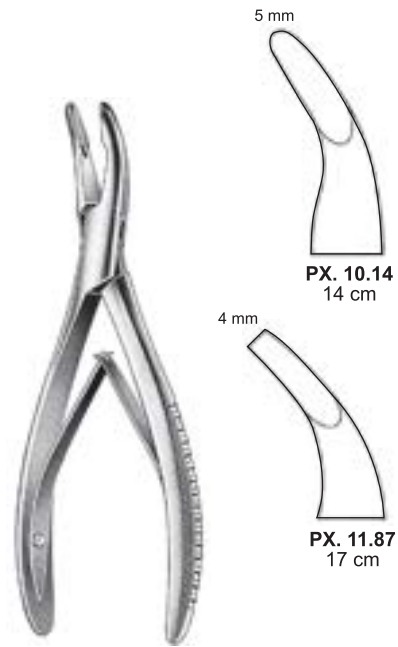

MEAD

PX. 10.14
 14 cm

PX. 11.87
 17 cm



SHELL
PX. 12.97
 17 cm

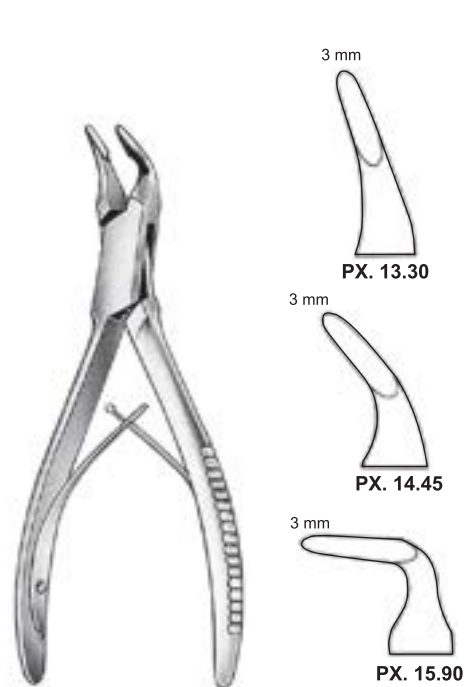

BLUMENTHAL
 15.5 cm

PX. 13.30

PX. 14.45

PX. 15.90

Bone rongeurs
 Hohlmeißelzangen
 Pinzas Gubias
 Pincas gouges



BACON
PX. 18.70
 20 cm



PX. 19.02



PX. 19.03

BEYER
 17 cm



LUER
 15 cm



PX. 20.55



PX. 20.65



PX. 20.75



LUER
 18 cm



PX. 22.17



PX. 22.18

Bone rongeurs
 Hohlmeißelzangen
 Pinzas Gubias
 Pincas gouges

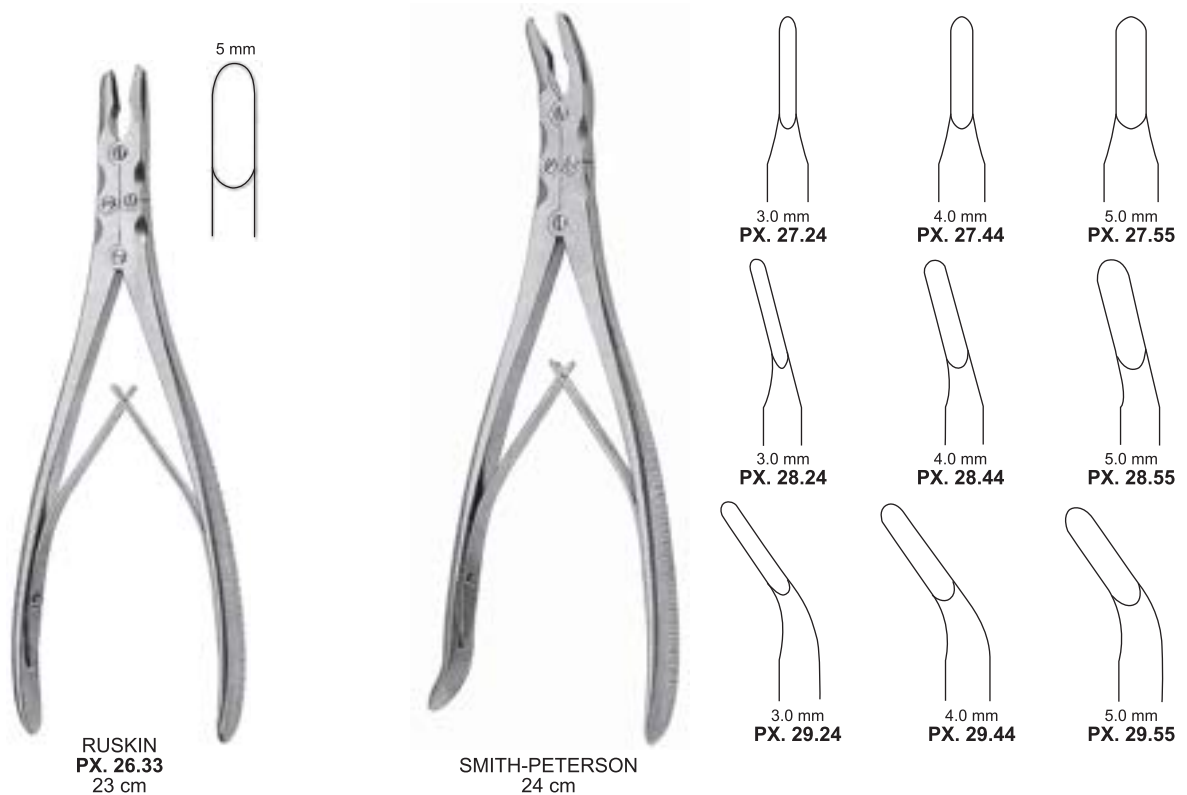
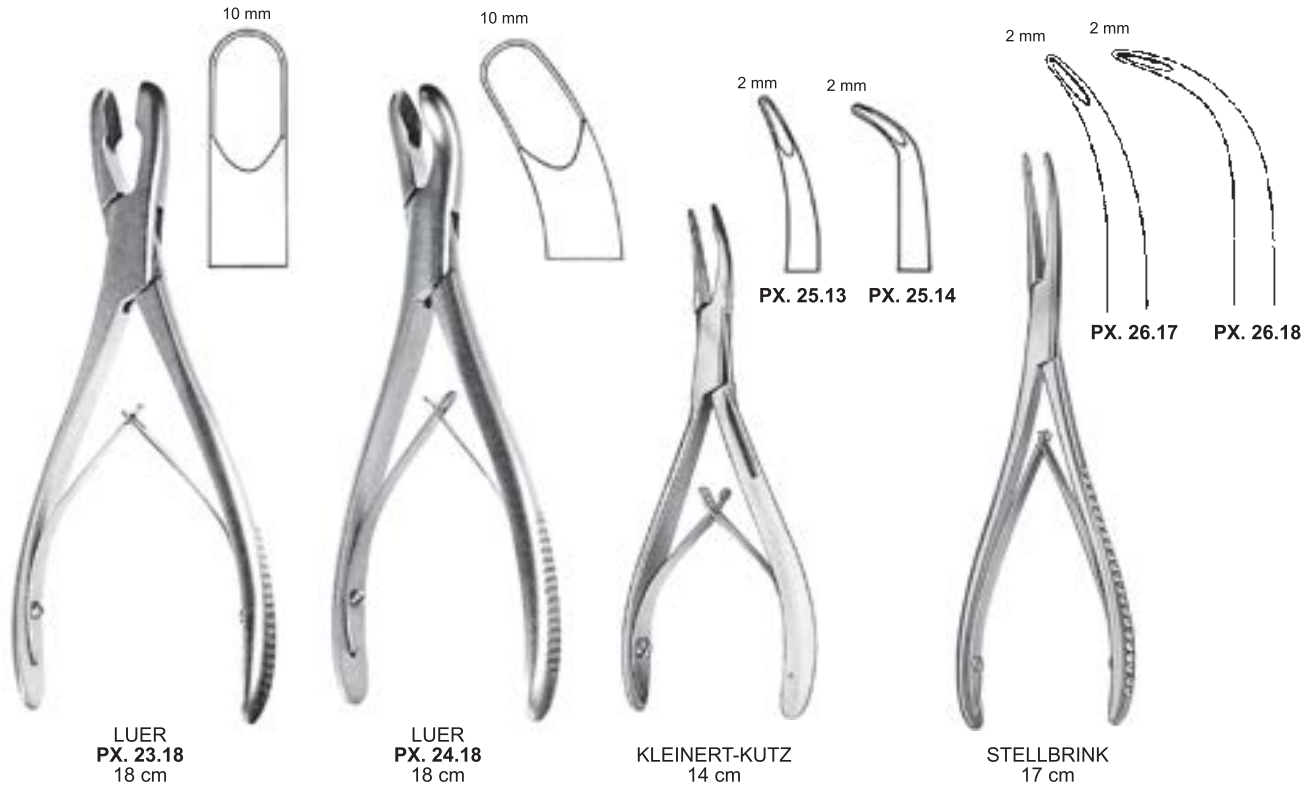

Bone rongeurs
 Hohlmeißelzangen
 Pinzas Gubias
 Pincas gouges



ZAUFAL-JANSEN
PX. 30.18
 18 cm



BEYER
PX. 31.18
 18 cm



BÖHLER
 15 cm

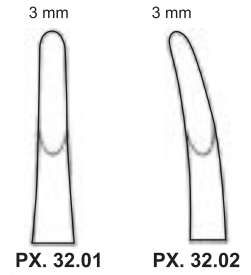

PX. 32.01

PX. 32.02



PX. 32.03



RUSKIN-MINI
 15 cm

<i>Straight</i>		<i>Curved</i>
PX. 32.15	2 mm	PX. 33.15
PX. 32.17	3 mm	PX. 33.17

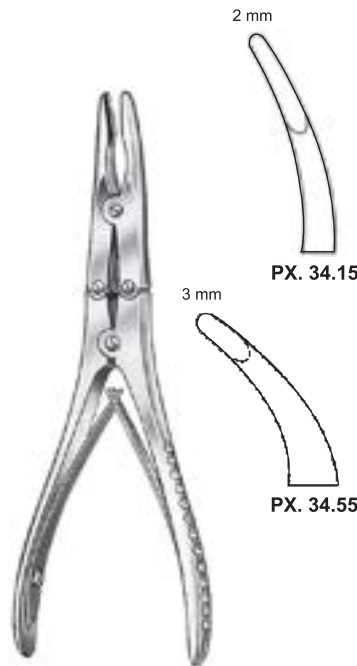

KLEINERT-KUTZ
 15 cm

PX. 34.15

PX. 34.55



RUSKIN
PX. 34.18
 18 cm

Bone rongeurs
 Hohlmeißelzangen
 Pinzas Gubias
 Pincas gouges



JANSEN
PX. 36.19
 19 cm



LEMPERT
PX. 37.19
 19 cm



LEMPERT
PX. 38.19
 19 cm



MAYFIELD
PX. 41.18
 17 cm



MARQUARDT
PX. 41.20
 20 cm



STILLE-LEKSELL
PX. 43.23
 23 cm

Bone rongeurs
 Hohlmeißelzangen
 Pinzas Gubias
 Pincas gouges

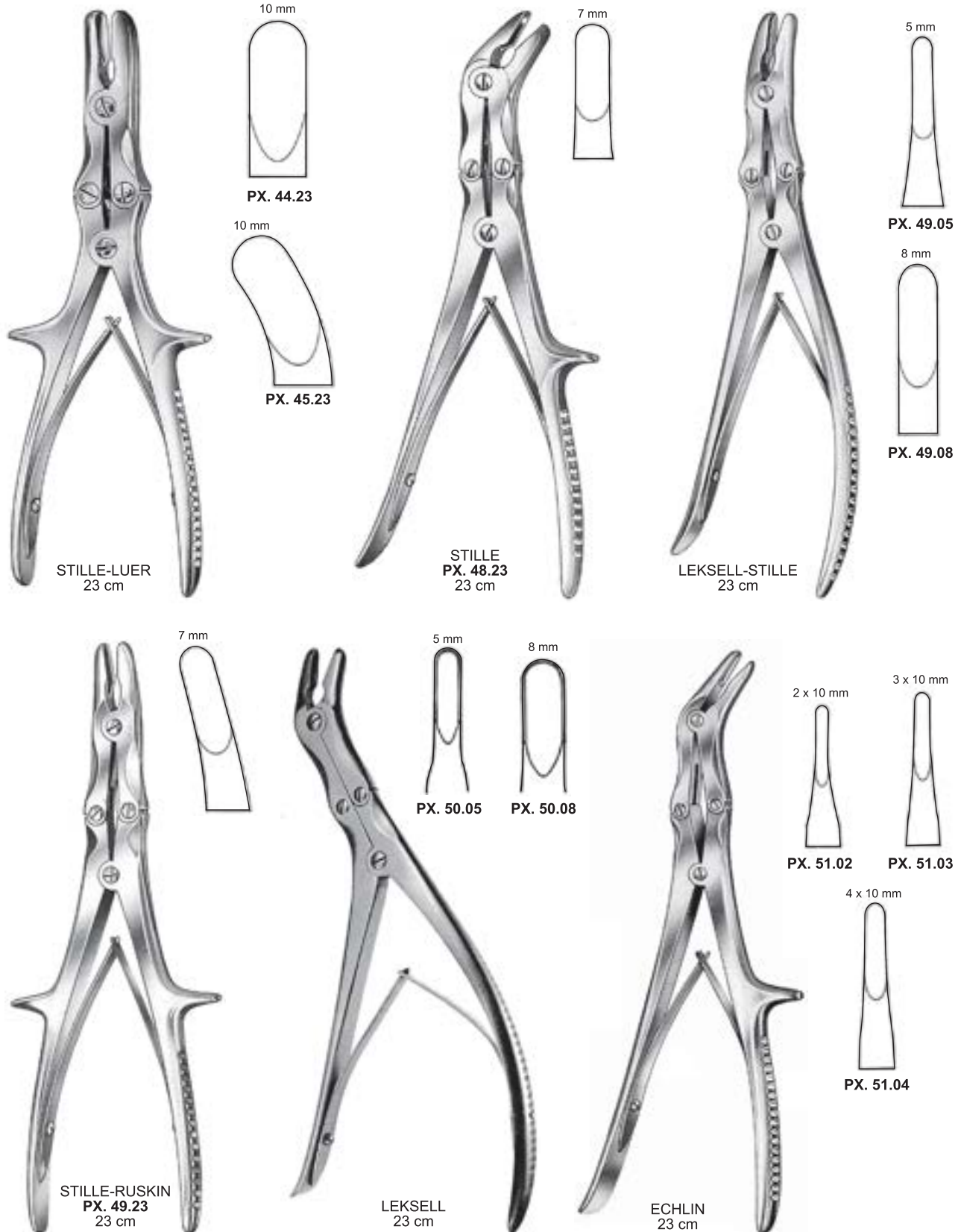

Bone rongeurs
 Hohlmeißelzangen
 Pinzas Gubias
 Pincas gouges

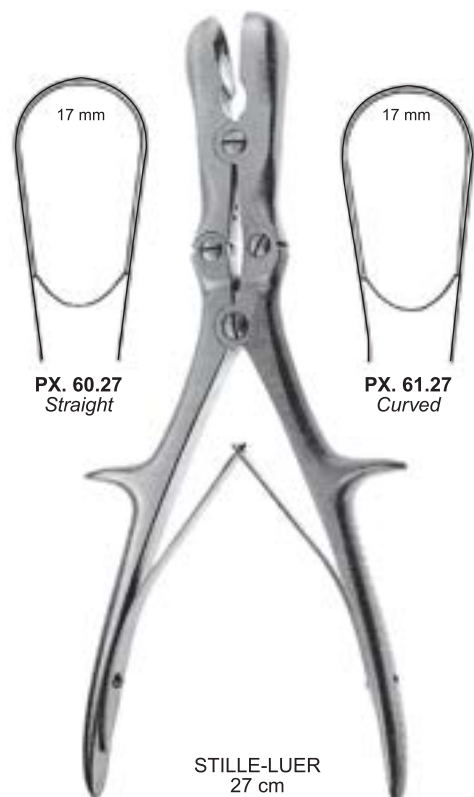
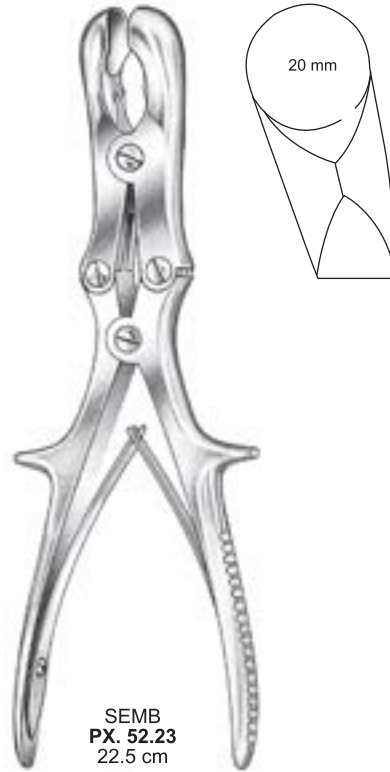

Hand bone drills

Handbohrapparate

Perforadores de mano para huesos

Perforateur à main

Finger ring saws and nail instruments

Fingerringsägen und Nagelzange

Sierras para abrir anillos y pinza para uñas

Scies pour bagues et pince à ongle



HUDSON
PAH. 53.00
27 cm
Complete with
PAH. 53.05 to PAH. 56.34



PAH. 53.05
10 cm



PAH. 54.00
ø 9 mm, 10 cm



PAH. 54.14
ø 14 mm, 10 cm



PAH. 55.16
ø 16 mm, 10 cm



PAH. 55.22
ø 22 mm, 10 cm



CUSHING
PAH. 56.34
ø 14 mm, 10 cm



WALTON
PAE. 03.00
16 cm



PAE. 04.00
17 cm



RADOLF
PAE. 15.15
13.5 cm

ADSON	Dressing & Tissue Forceps	7	HALSTEAD-MOSQUITO	Hemostatic Forceps	8
ADSON	Dressing & Tissue Forceps, TC	7	HARTMANN	Bone Rongeur	61
ADSON	Elevators	27	HENNIG	Plaster Cast Breaker	21
ADSON	Haemostatic Forceps	11	HIBBS	Chisels & Gouges	50
ADSON	Laminectomy Retractors	16	HIBBS-SPRATT	Bone Curettes	56
ALDERDYCE	Elevators	29	HOEN	Elevators	26
ALEXANDER	Chisels & Gouges	49	HOHMANN	Bone Levers	31,32
BACKHAUS	Towel Clamps	12	HOKE	Chisels & Osteotomes	48
BACON	Bone Rongeur	62	HOPKINS	Plaster of Paris Knives	21
BECKMANN-ADSON	Laminectomy Retractors	16	HORSLEY-STILLE	Bone Cutting Forceps	36
BECKMANN-EATON	Laminectomy Retractors	16	HUDSON	Hand Drills	68
BEESON	Plaster Spreader	21	IRIS	Delicate Scissors	3
BERGMANN	Bandage Scissors	20	IRIS	Delicate Scissors, TC	4
BERGMANN	Mallets	24	JANSEN	Bone Curettes	58,59
BEYER	Bone Rongeur	62,64	JANSEN	Bone Rongeur	65
BLOUNT	Bone Lever	32	JANSEN	Retractors	16
BLOUNT	Knee Retractors	33	JOSEPH	Periosteal Elevators	26
BLUMENTHAL	Bone Rongeur	61	KERN	Bone Holding Forceps	41
BOHLER	Bone Rongeur	64	KIRK	Mallet	22
BOHLER	Traction Bow	44	KIRMISSION	Periosteal Raspatory	28
BRUNS	Bandage Scissors	20	KLEINERT-KUTZ	Bone Cutting Forceps	35
BRUNS	Bone Curettes	55	KLEINERT-KUTZ	Bone Rongeur	63,64
BRUNS (VOLKMANN)	Bone Curettes	56,58	KOCHER	Hemostatic Forceps	11
CHARRIERE	Amputation Saw	44	KONRICH	Sterilizing Dressing Drums	17
CHEATLE	Sterilizing Forceps	17	LAMBOTTE	Bone Holding Forceps	41,42
CHERON	Dressing Forceps	8	LAMBOTTE	Chisels	52
CLEVELAND	Bone Cutting Forceps	34	LAMBOTTE	Raspatories	29
COBB	Elevators	29	LANE	Bone Holding Forceps	41
COBB	Gouges	51	LANGE-HOHMANN	Bone Levers	32
COLLIN	Mallet	23	LANGENBECK	Amputation Saw	44
COTTLE	Mallet	24	LANGENBECK	Bone Holding Forceps	39
COTTLE-KAZANJIAN	Bone Cutting Forceps	34	LANGENBECK	Elevators & Raspatories	29,30
CRILE-WOOD	Needle Holder	13	LANGENBECK	Raspatories	29
CRILE-WOOD	Needle Holder, TC	13	LANGENBECK	Retractors	15
CUSHING	Perforator	68	LEKSELL	Bone Rongeur	66
DAHMEN	Chisel	53	LEKSELL-STILLE	Bone Rongeur	66
DINGMAN	Bone Holding Forceps	38	LEMPERT	Bone Rongeur	65
DOYEN	Mallets	24	LEMPERT	Periosteal Elevators	27
DOYEN	Raspatories	30	LEWIN	Bone Holding Forceps	39
ECHLIN	Bone Rongeur	66	LEXER	Chisels & Gouges	51,53,54
ENGEL	Plaster of Paris Saw	21	LISTER	Bandage Scissors	20
ESMARCH	Bandage Scissors	20	LISTER	Bandage Scissors, TC	20
ESMARCH	Plaster of Paris Knives	21	LISTON	Bone Cutting Forceps	34,35
FARABEUF	Bone Holding Forceps	41	LISTON-KEY	Bone Cutting Forceps	36
FARABEUF	Raspatories	28	LISTON-MINI	Bone Cutting Forceps	35
FARABEUF	Retractor	15	LISTON-STILLE	Bone Cutting Forceps	35
FARABEUF-BABY	Retractor	15	LITTAUER-LISTON	Bone Cutting Forceps	34
FARABEUF-LAMBOTTE	Bone Holding Forceps	41	LOUTE	Wire Twister	45
FERGUSSON	Bone Holding Forceps	39	LOWMAN	Bone Holding Clamps	37
FOERSTER	Sponge Holding Forceps	8	LUCAE	Mallets	23
FREER	Elevators	29	LUCAS	Chisels & Osteotomes	50
FRIEDMAN	Bone Rongeur	60	LUER	Bone Rongeur	62,63
FRYKHOLM	Bone Rongeur	67	MARQUARDT	Bone Rongeur	65
GEMINI	Dissecting & Ligature Forceps	12	MARTIN	Bone Holding Forceps	39
GERSTER-LOWMANN	Bone Holding Forceps	37	MARTINI	Bone Curettes	58
GERZOG	Mallet	22	MATHIEU	Needle Holder, TC	14
GIGLI	Wire Saws & Handle	44	MATHIEU-KOCHER	Needle Holder, TC	14
HAJEK	Mallet	23	MAYFIELD	Bone Rongeur	65
HALLE	Bone Curettes	57	MAYO	Operating & Dissecting Scissors	3
HALSTEAD-ADSON	Hemostatic Forceps	11	MAYO	Operating & Dissecting Scissors, TC	4

MAYO	Safety Pin	17	STILLE	Bone Rongeurs	66
MAYO-HARRINGTON	Operating & Dissecting Scissors	3	STILLE	Chisels & Gouges	48,49
MAYO-HARRINGTON	Operating & Dissecting Scissors, TC	4	STILLE	Plaster Shears	21
MAYO-HEGAR	Needle Holders	13	STILLE-LEKSELL	Bone Rongeurs	65
MAYO-HEGAR	Needle Holders, TC	13	STILLE-LUER	Bone Rongeurs	66,67
MAYO-STILLE	Operating & Dissecting Scissors	3	STILLE-RUSKIN	Bone Rongeurs	66
MAYO-STILLE	Operating & Dissecting Scissors, TC	4	TAYLOR	Bone Levers	32
MCDONALD	Dissector	26	THIESS	Mallet	23
MCINDOE	Bone Cutting Forceps	35	TRAUTMANN	Chisels & Gouges	48
MEAD	Bone Rongeur	60,61	ULRICH	Bone Holding Forceps	40
MEAD	Mallets	22	UNIVERSAL	Bandage & Wire Cutting Scissors	20
METZENBAUM	Dissecting Scissors, TC	5	UNIVERSAL	Bone Rongeur	60
METZENBAUM (LAHEY)	Dissecting Scissors, TC	5	UNIVERSAL	Wire Cutter	46
MILLER	Bone Rasps	25	UNIVERSAL	Wire Cutter, TC	46
MINI-FRIEDMAN	Bone Rongeur	60	VAN BUREN	Bone Holding Forceps	37
MINI-HOHMANN	Bone Levers	31	VERBRUGGE	Bone Holding Forceps	42
MINI-LAMBOTTE	Chisels	48	VOLKMANN	Bone Curettes	57,59
MINI-LEXER	Chisels & Gouges	54	VOLKMANN	Retractors	15
MIXTER	Dissecting & Ligature Forceps	12	WALTON	Finger Ring Cutter	68
MIXTER-BABY	Dissecting & Ligature Forceps	12	WEITLANER	Retractors	16
MOD. USA	Plaster Cast Breaker	21	WIGMORE	Plaster of Paris Saw	21
MOLT	Periosteal Elevators	26	WILLIGER	Bone Curettes	58
MOYNIHAN	Hemostatic Forceps	11	WILLIGER	Elevators	26
NELSON (METZENBAUM)	Dissecting Scissors, TC	5	WILLIGER	Mallets	24
OLIVECRONA	Bone Rongeur	61	WILLIGER	Raspatories	26
OMBERDANNE	Mallet	24	WOLFF	Plaster Cast Breaker	21
PARTSCH	Chisels & Gouges	48	YANKAUER	Suction Tubes	2
PARTSCH	Mallet	23	ZAUFAL-JANSEN	Bone Rongeur	64
PEAN	Hemostatic Forceps	11			
POOLE	Suction Tubes	2			
POTTS-SMITH	Dissecting Forceps, TC	7			
PUTTI	Bone Files	25			
RADOLF	Nail Pulling Forceps	68			
RANKIN-CRILE	Hemostatic Forceps	8			
RANKIN-KELLY	Hemostatic Forceps	8			
REINER	Plaster of Paris Knife	21			
ROCHESTER-OSCHNER	Hemostatic Forceps	10			
ROCHESTER-PEAN	Hemostatic Forceps	9			
RUSKIN	Bone Rongeur	63,64,67			
RUSKIN-LISTON	Bone Cutting Forceps	36			
RUSKIN-MINI	Bone Rongeur	64			
RUSKIN-ROWLAND	Bone Cutting Forceps	36			
RYDER (FRENCH EYE)	Needle Holders, TC	14			
SATTERLEE	Amputation Saw	44			
SCHEDE	Bone Curettes	57			
SCHELL	Bone Rongeur	61			
SCHIMMELBUSCH	Sterilizing Dressing Drums	17			
SEDILLOT	Raspatories	27			
SEMB	Bone Cutting Forceps	36			
SEMB	Bone Holding Forceps	39			
SEMB	Bone Rongeur	67			
SEMB	Raspatories	28			
SENN-MUELLER	Retractors	15			
SEUTIN	Bandage Scissors	20			
SMILLIE	Knee Retractors	33			
SMILLIE	Meniscotomes	54			
SMITH-PETERSON	Bone Rongeurs	63			
SMITH-PETERSON	Chisels & Gouges	52			
SPRATT	Bone Curettes	56			
STELLBRINK	Bone Rongeurs	63			

CONTACT US:



T.I.G International
3/199 Street No.1,
Puran Nagar Paris Road,
Sialkot-51310, Pakistan.

Tel: +92 52 3559212
Fax: +92 52 3559212
Hotline: +92 300 6166818
WhatsApp: +92 333 8785863
Email: info@tig-int.net / tigint786@hotmail.com
URL: www.tig-int.net



CE
Mark Approved